



# ICM

Inline Contamination Monitor

## User Guide



[www.mpfiltri.co.uk](http://www.mpfiltri.co.uk)

200.000-EN

Covers All ICM Models except -AZ2 (ATEX)

## SAFETY WARNING

Hydraulic systems contain dangerous fluids at high pressures and temperatures. Installation, servicing and adjustment is only to be performed by qualified personnel.

Do not tamper with this device.

# Contents

<b>1</b>	<b>Introduction</b>	<b>5</b>
	• <i>Operating Principle</i>	
<b>2</b>	<b>How to Order</b>	<b>6</b>
	• <i>Related Products</i>	
<b>3</b>	<b>Specification</b>	<b>8</b>
	• <i>Performance</i> • <i>Hydraulic</i> • <i>Environmental</i> • <i>Physical</i> • <i>Electrical</i> • <i>Warranty and Recalibration</i>	
<b>4</b>	<b>Status LED</b>	<b>11</b>
<b>5</b>	<b>Front Panel Operation</b>	<b>13</b>
	• <i>Result Display</i> • <i>Diagnostics Display</i>	
<b>6</b>	<b>Water Sensor</b>	<b>17</b>
<b>7</b>	<b>Data Logger</b>	<b>19</b>
<b>8</b>	<b>Remote Display Unit Option</b>	<b>20</b>
<b>9</b>	<b>USBi Optional Computer USB Interface</b>	<b>21</b>
<b>10</b>	<b>Remote Control</b>	<b>22</b>
	• <i>Computer Connection</i>	
<b>11</b>	<b>PC Software Operation</b>	<b>24</b>
<b>12</b>	<b>Settings</b>	<b>26</b>
	• <i>General</i> • <i>Test Number</i> • <i>Test Duration</i> • <i>Result Display</i> • <i>Simulated Test</i> • <i>Low Flow Alarm Disabled (Clean Systems)</i> • <i>Continuous Testing</i> • <i>Alarms</i>	

<b>13</b>	<b>Installation</b>	<b>36</b>
	• <i>Installation Procedure</i>	
<b>14</b>	<b>Electrical Interface</b>	<b>38</b>
	• <i>DC Power</i> • <i>Serial Interface</i> • <i>Switched Input and Output Signals</i> • <i>Start Signal</i>	
	• <i>Alarm Outputs</i>	
<b>15</b>	<b>Hydraulic Connection</b>	<b>43</b>
	• <i>Flow Rate</i> • <i>Manual Flow Control</i> • <i>Active Flow Control</i>	
<b>16</b>	<b>Fault Finding</b>	<b>48</b>
	• <i>LED Flashing / Fault Codes</i> • <i>Test Status</i> • <i>Other Faults</i>	
<b>17</b>	<b>Cycle Time and Flow Rate Considerations</b>	<b>51</b>
<b>18</b>	<b>Modbus Programming</b>	<b>53</b>
	• <i>Reading the Result Codes</i>	
<b>A</b>	<b>Measuring Water in Hydraulic and Lubricating Fluids</b>	<b>55</b>
<b>B</b>	<b>ISO4406:1999 Cleanliness Code System</b>	<b>57</b>
<b>C</b>	<b>NAS1638 Cleanliness Code System</b>	<b>59</b>
<b>D</b>	<b>SAE AS4059 REV.E Cleanliness Classification For Hydraulic Fluids</b>	<b>60</b>
<b>E</b>	<b>Recommendations</b>	<b>62</b>
<b>F</b>	<b>Hydraulic System Target Cleanliness Levels</b>	<b>64</b>
<b>G</b>	<b>New ISO Medium Test Dust and its effect on ISO Contamination Control Standards</b>	<b>66</b>
	• <i>Calibration</i> • <i>New Test Dust Benefits</i> • <i>Effect on Industry</i> • <i>Correlation</i> • <i>Other Standards</i>	
<b>H</b>	<b>Clean working practises</b>	<b>71</b>

# 1 Introduction

The ICM measures and quantifies the numbers of solid contaminants in Hydraulic, Lubrication and Transmission applications. The ICM-M is designed to be an accurate instrument for permanently installed applications utilising mineral oil as the operating fluid. Other fluid media versions are available.

The unit can operate using any of the international standard formats ISO 4406:1999, NAS 1638, AS 4059E and ISO 11218.

The ICM incorporates a serial data connection for comprehensive remote control and monitoring.

The integrated data logger records up to 4000 test results internally, for use where a computer cannot be permanently connected.

Simple switched inputs and alarm outputs are provided as alternative means of controlling the testing and signalling the results. The "full colour" front panel led provides a basic indication of the cleanliness level.

The graphical LCD allows direct local display of the results in any selected format.

ICM-W models also perform a measurement of % saturation of Water in oil (RH), and fluid temperature (°C).

## 1.1 Operating Principle

The instrument uses a light extinction principle whereby a specially collimated precision LED light source shines through the fluid and lands on a photodiode. When a particle passes through the beam it reduces the amount of light received by the diode, and from this change in condition, the size of the particle can be deduced.

## 2 How to Order

Example: **ICM** - **W** **M** **K** **R** **G1**

Example: **ICM** - **0** **M** **0** **0** **G3**

**ICM** *Common Features* – All versions can be controlled by a PC, PLC or the ICM-RDURemote Display Unit. Included is time-stamped data-logging for around 4000 tests, an integral status LED to indicate fault conditions, RS485 communications and measurement in multiple international standard formats. All units include 3m pre-wired control cable and LPA-View test analysis software. For more details see the product brochure and the Specification (3).

The *base unit* for remotely controlled embedded applications and comes without key-pad and LCD.

**W** Adds Water and Temperature Sensing.<sup>1</sup> See section 6. "0" if not required.

**M** Mineral Oil Fluid Compatibility. Also *N* – Offshore and selected water based fluids. *S* – Phosphate ester and aggressive fluids.

**K** Keypad – Adds graphical LCD and a key-pad. See section 5. "0" if not required.

**R** Adds settable upper and lower limits for the test results, with two programmable "Alarm" relay outputs<sup>2</sup>. The full colour front panel LED indicator also reflects the test results, indicating if any set limits have been exceeded. See section 12.8. "0" if not required.

**G1** M16x2 Mini-mess connections (ICM Standard). Also **G3** – 1/4", **G4** – 7/16th UNF.

<sup>1</sup> For high frequency pressure pulse applications contact MP Filtri UK Ltd.

<sup>2</sup> This option, together with K, is also required in order to display detailed particle counts on the LCD. The option also provides a switched start signal input.

## 2.1 Related Products

### 2.1.1 ICM-RDU

The ICM-RDU is a separate product that is used to remotely monitor or control an ICM. It is normally used when the ICM is in a location unsuitable for a display, such as an engine compartment. See section 8

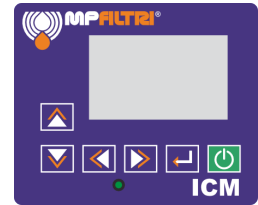

**Figure 1** RDU

### 2.1.2 ICM-FC1

A pressure compensated flow control valve suitable for the ICM. This may be needed if the application produces an oil flow that varies outside the upper flow range of the unit.

### 2.1.3 ICM-USBi

USB interface adaptor for the ICM.

This is a ready-made solution for easily connecting a computer to the ICM.



**Figure 2** USBi

It comprises a USB:RS485 interface with a terminal block pre-wired with the ICM cable. An extra terminal block is provided for any customer wiring to external devices. An external DC adapter can be used to power the complete system, or if the computer is always connected during use, power can be taken directly from the USB cable.

Full usage instructions are provided in the separate product user guide.

# 3 Specification

## 3.1 Performance

<b>Technology</b>	Precision LED Based Light Extinction Automatic Optical Particle Analyser
<b>Particle Sizing</b>	>4,6,14,21,25,38,50,70 µm(c) to ISO 4406:1999 Standard
<b>Analysis Range</b>	ISO 4406:1999 Code 0 to 25 NAS1638 Class 00 to 12 AS4059 Rev.E. Table 2 Sizes A-F : 000 to 12 Lower Limits are Test Time dependent. <i>If system above 22/21/18 or approx. NAS 12 a coarse screen filter should be fitted to prevent blockage. This is available from MP Filtri UK Part SK0040.</i>
<b>Reporting Formats</b>	ISO 4406:1999 (ICM Default) NAS1638 AS4059E Table 2 AS4059E Table 1 ISO 11218
<b>Accuracy</b>	±½ ISO code for 4,6,14µm(c) ±1 code for 21,25,38,50,70 µm(c)
<b>Calibration</b>	Each unit individually calibrated with ISO Medium Test Dust (MTD) based on ISO 11171 (1999), on equipment certified by IFTS.
<b>Test Time</b>	Adjustable 10 - 3600 seconds (factory set to 120s)
<b>Moisture &amp; Temperature Measurement</b>	% saturation (RH) and fluid temperature(°C) – Mineral Oil Only. See section 6
<b>Data Storage</b>	Approximately 4000 timestamped tests in the integral ICM memory.
<b>Keypad &amp; LCD</b>	6 keys, 128x64 pixels, back-lit graphical display

## 3.2 Hydraulic

<b>Fluid Compatibility</b>	Standard unit: Mineral oil & petroleum based fluids . Consult MP Filtri UK for other fluids.
----------------------------	--



<i>Flow Rate</i>	20-400 ml/minute
<i>Viscosity Range</i>	<1000 cSt
<i>Fluid Temperature</i>	-25 to +85 °C (check for viscosity compatibility for low temperature)
<i>Maximum Pressure</i>	400 bar static. For high frequency pressure pulse applications contact MP Filtri UK.
<i>Differential (Inlet-Outlet) Pressure</i>	Typically 0.5 bar, see section 15.1.
<i>Seal Material</i>	Viton. Contact MP Filtri UK for any fluids that are incompatible with Viton seals.

### 3.3 Environmental

<i>Ambient Temperature</i>	-25 to + 80 °C for non Kversion, -25 to + 55°C for Kversion
<i>IP Rating</i>	P 65/67 Versatile IP66

### 3.4 Physical

<i>Dimensions</i>	117mm(H)x142mm(W)x65mm(D).
<i>Fixing Holes</i>	Centers 126mm apart, Diameter 6.9mm (for M6).
<i>Weight</i>	1.15kg

### 3.5 Electrical

*Supply Voltage* 9-36V DC

*Supply Current*

	12V	24V	36V	
	150mA	80mA	60mAfor	Kversion
	70mA	40mA	30mAfor	non Kversion

*Power Consumption* 2.2W

*Switched Inputs & Outputs* see section 14.3 for details

### **3.6 Warranty and Recalibration**

*Warranty*                      The ICM is guaranteed for 12 months from date of receipt.

*Re-calibration*                The ICM is recommended to be recalibrated every 12 months. Return to MP Filtri UK for recalibration.

As a policy of continual improvement, MP Filtri UK reserve the right to alter the specification without prior notice.

## 4 Status LED

All ICM versions have a multicolour indicator<sup>3</sup> on the front panel, which is used to indicate the status or alarm state. The alarm thresholds can be set from LPA-View via the serial interface.

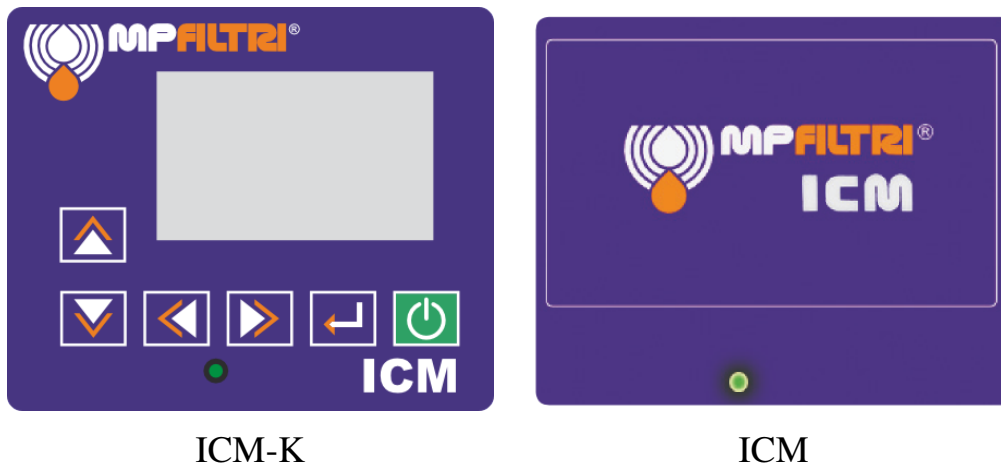

**Figure 1** Front Panel Versions

- *Green* indicates that the test result passed, i.e. none of the alarm thresholds were exceeded.
- *Yellow* indicates that the lower cleanliness limit was exceeded, but not the upper one.
- *Red* indicates that the upper cleanliness limit was exceeded.
- *Blue* indicates that the upper water content limit was exceeded.
- *Red/Blue Alternating* indicates both cleanliness and water content upper limits exceeded.
- *Violet* indicates that the upper temperature limit was exceeded.<sup>4</sup>

<sup>3</sup> If all these codes seem confusing, please note that a given colour will only ever be seen if the corresponding limit has been specifically set by the user. So for example if a maximum temperature limit has not been set, the violet indication will never be seen. If all that is wanted is a "green or red" light, that can be arranged by simply setting only the cleanliness threshold maximum limit.

<sup>4</sup> This alarm, *if set*, takes priority over the Contamination and Water alarms. In the event of an over-temperature condition, the LED will turn violet only, whether or not there is also a contamination or water alarm condition. The rationale is that an over-temperature condition could be immediately catastrophic for the hydraulic system.

- The LED can also indicate various fault codes by turning red and flashing white a number of times, see section 16.1.

# 5 Front Panel Operation

## 5.1 Result Display

ICM-Kmodels have a 6 button keypad and a small graphical LCD. This allows the display of the test result (current cleanliness level, with water content and temperature if applicable).

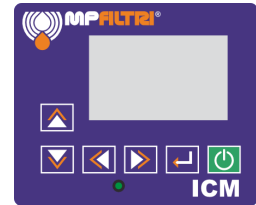

Figure 1

The graphical format allows a full display of all codes of the standards supported. The unit powers up in "Display Mode". This displays the test result in the selected format. Figures 2 onward show those available.<sup>5</sup> The screenshots on the right are the "detailed" version of the display additionally showing the particle counts and flow rate. The particle sizes and count representation are automatically matched to the selected format.

There is also a "History" screen which shows the last 10 results.

The operator can switch between these screens using the ▲ and ▼ keys.

The horizontal line is the progress bar, it grows from left to right as the test progresses. When it reaches the right hand side a new result is generated.

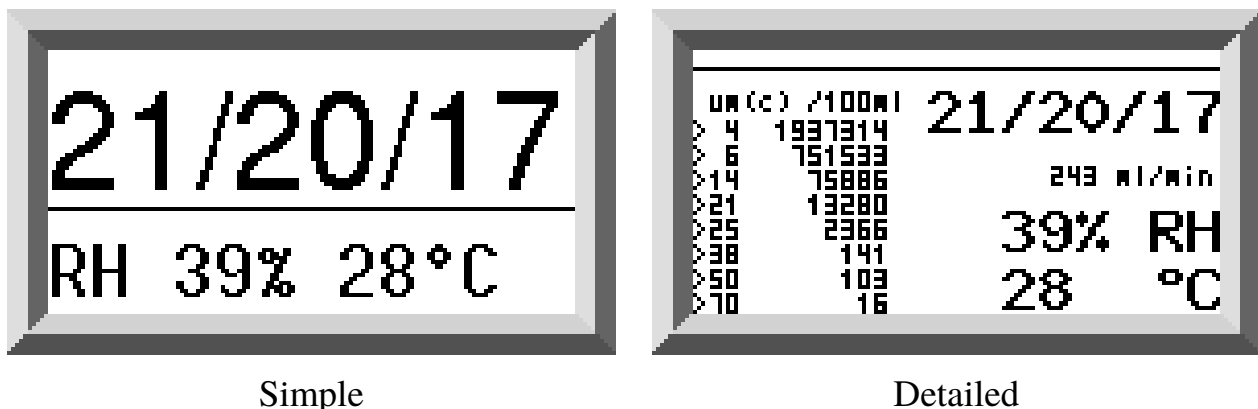
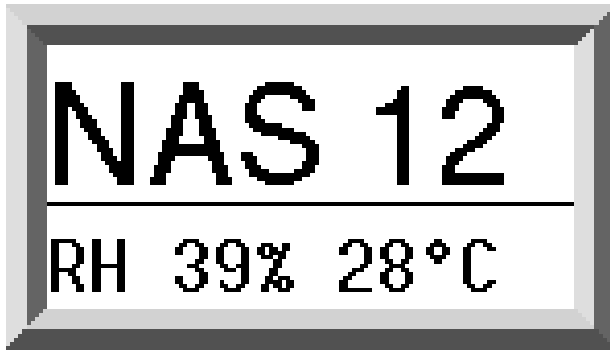
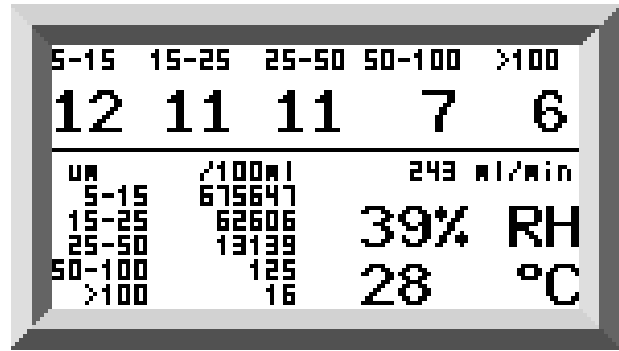

Figure 2 ISO4406:1999

<sup>5</sup> The selected format is typically set during installation (using LPA-View). The rationale is that each industry or company will have its preferred format, it is not something that an operator should be changing.



Simple



Detailed

Figure 3 NAS1638

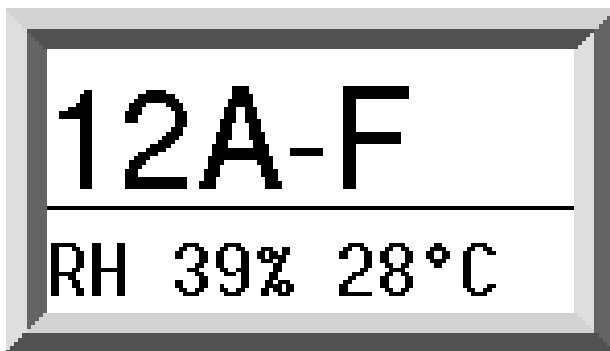

Simple

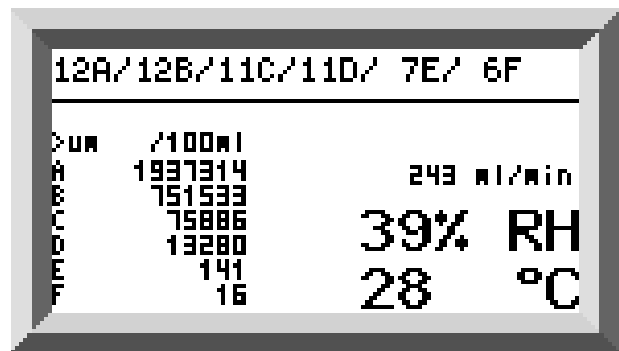

Detailed

Figure 4 AS4059E Table 2

## 5.2 Diagnostics Display

Press to show the diagnostics displays (used when diagnosing problems). Then switch between the diagnostics screens using the and buttons.

*Completion* shows a number from 0 to 1000, indicating the test progress. *FLOW ml/min* provides an approximate indication of flow rate, updated after each test. This can be helpful when installing the unit or checking operation, to ensure that the flow rate is within the limits of the unit. The other items are mainly of use to assist in support when reporting problems.

The *STATUS* line shows the current state of the unit. Any errors such as *LOW FLOW* will also appear here.<sup>6</sup>

<sup>6</sup> These correspond to the front panel LED fault codes.

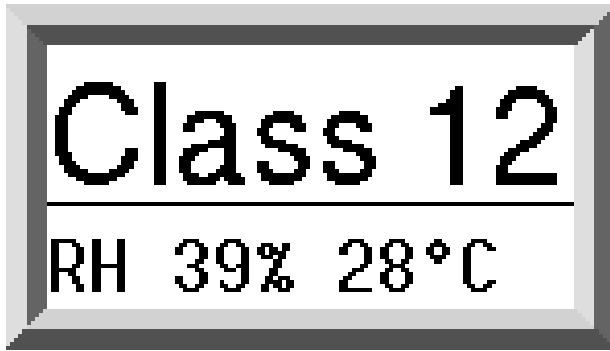

Simple

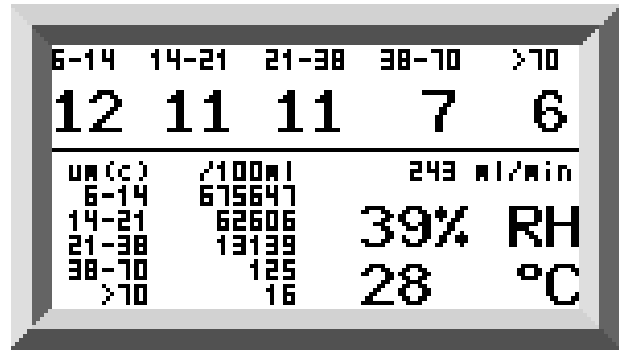

Detailed

**Figure 5** AS4059E Table 1

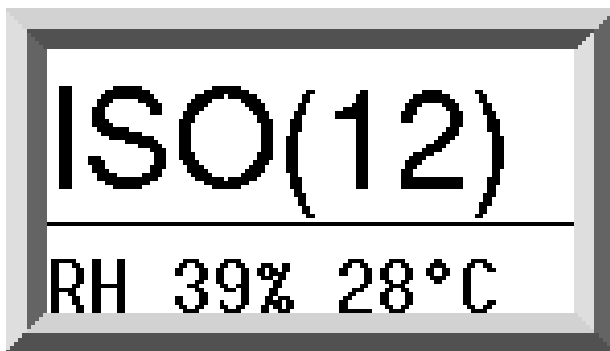

Simple

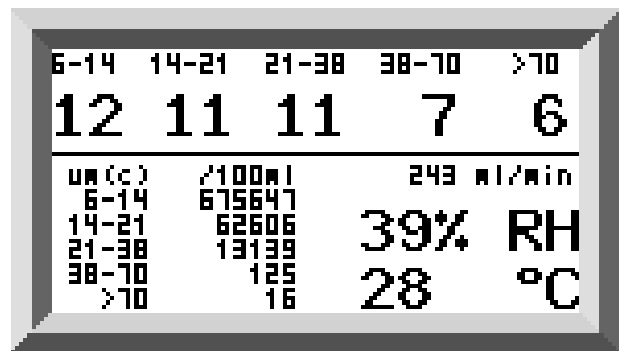

Detailed

**Figure 6** ISO11218 (Draft)

The second screen shows diagnostics relating to Modbus serial communications traffic. *External Comms Errors* are those between a connected PC and the ICM. *Internal Comms Errors* are internal to the unit, showing communications between the ICM keyboard/display circuit board and the sensor itself.

The third screen shows diagnostics related to CAN bus communications. For more details refer to the separate ICM CAN bus manual.

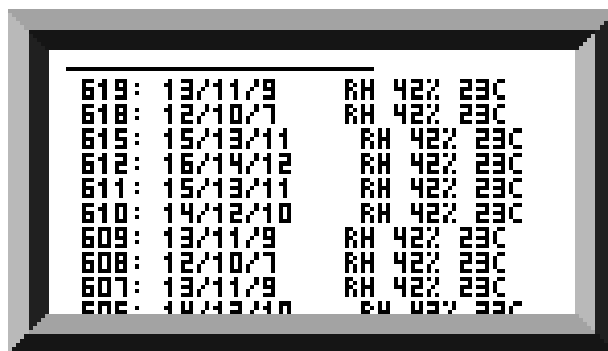

**Figure 7** History Screen



General



Modbus

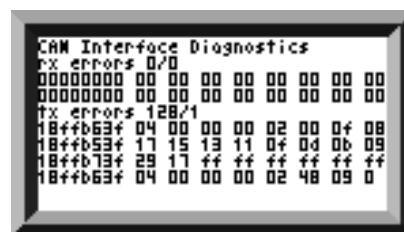

CAN Bus

**Figure 8** Diagnostic Screens



## 6 Water Sensor

ICM-W models measure water content using a capacitive RH (relative humidity) sensor. The result is expressed as percentage saturation. 100% RH corresponds to the point at which free water exists in the fluid, i.e. the fluid is no longer able to hold the water in a dissolved solution. This is also normally the point at which damage occurs in a hydraulic system, so is an ideal measurement scale that is independent of the fluid characteristics.

The water saturation point (100% RH) is temperature dependent, so the temperature is measured at the same time.<sup>7</sup> This enables results to be compared meaningfully.

The water sensor output is affected by pressure, so the accuracy will be proportionally degraded above 100 bar operating pressure.

---

<sup>7</sup> The temperature measured is that of the fluid passing through the unit. Note this may differ from that of the hydraulic system, depending on flow rate, pipe length and ambient temperature. It is not intended to be an accurate indication of system temperature, but to provide a reference for the RH measurement. Nevertheless experience has shown the temperature measured is within a few degrees of that of the hydraulic system, in most applications.

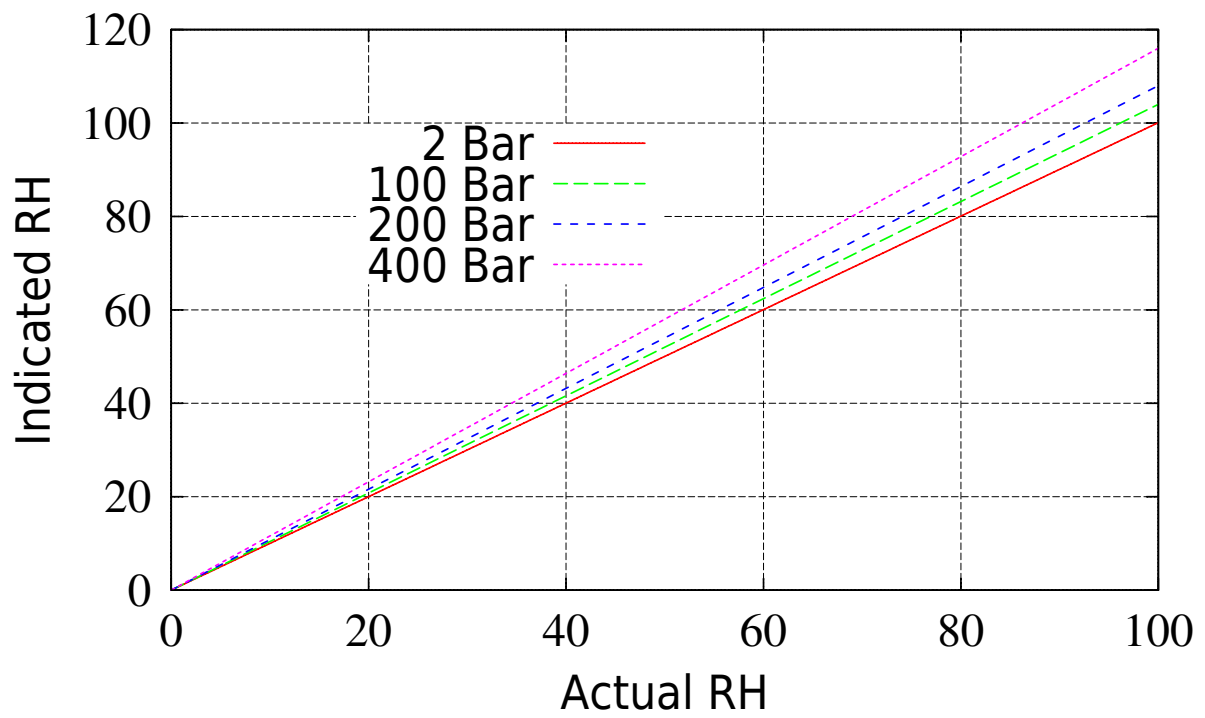

**Figure 1** Water Sensor Response variation with Absolute Pressure

# 7 Data Logger

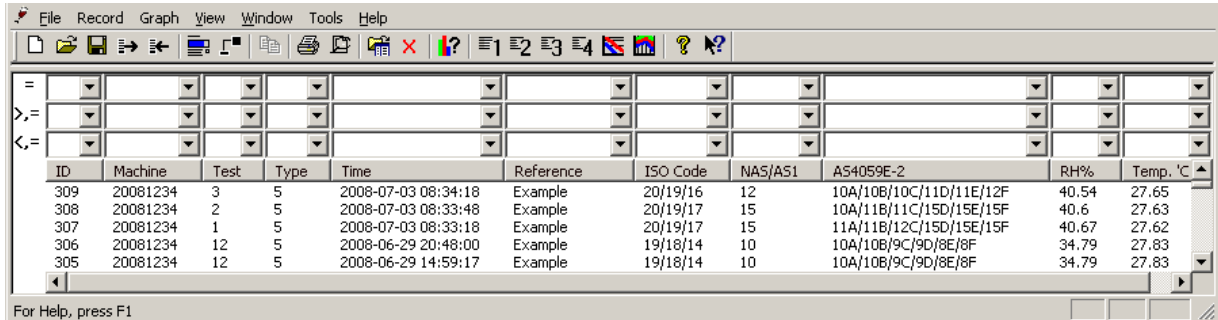

The screenshot shows the ICM data logger software interface. It features a menu bar (File, Record, Graph, View, Window, Tools, Help) and a toolbar with various icons. Below the toolbar is a configuration area with several dropdown menus and input fields. The main area displays a table of log entries with the following data:

ID	Machine	Test	Type	Time	Reference	ISO Code	NAS/A51	A54059E-2	RH%	Temp. °C
309	20081234	3	5	2008-07-03 08:34:18	Example	20/19/16	12	10A/10B/10C/11D/11E/12F	40.54	27.65
308	20081234	2	5	2008-07-03 08:33:48	Example	20/19/17	15	10A/11B/11C/15D/15E/15F	40.6	27.63
307	20081234	1	5	2008-07-03 08:33:18	Example	20/19/17	15	11A/11B/12C/15D/15E/15F	40.67	27.62
306	20081234	12	5	2008-06-29 20:48:00	Example	19/18/14	10	10A/10B/9C/9D/8E/8F	34.79	27.83
305	20081234	12	5	2008-06-29 14:59:17	Example	19/18/14	10	10A/10B/9C/9D/8E/8F	34.79	27.83

At the bottom of the window, it says "For Help, press F1".

The ICM includes a built-in data logger, which adds the facility to log and time-stamp<sup>8</sup> test results locally within an internal memory, even when not connected to a computer.

- Tests that are logged, and when, are determined by the log settings (see section 12.7).
- Each log entry is time-stamped and contains the ICM serial number, so that it can be identified later.
- The ICM memory has space for around 4000 log entries. When full, the oldest log entry is overwritten.

See chapter 11 for details of how to download the test log.

---

<sup>8</sup> Factory setting for ICM system time is GMT, it can be updated to local time via Usbi and/or Modbus.

## 8 Remote Display Unit Option

The optional ICM-RDU is a separate box that just contains the keypad and display. The sensor itself is mounted remotely in another box. This allows the operator full control of the ICM even when the sensor itself is not easily accessible. The ICM-RDU connects "in between" the incoming supply/serial connections, and the ICM sensor. It is "transparent" to the serial communications. This means that a PLC or LPA-View can operate in the usual way to control the ICM, change settings or download results, without having to unplug the RDU.

The same components are used for the RDU as for the normal ICM -Koption, so the same instructions apply for operation. See chapter 5 for more details.

The RDU wiring details are shown in figure 4.

## 9 USBi Optional Computer USB Interface



**Figure 1** ICM-USBi: A USB Interface Unit for the ICM

This is a ready-made solution for easily connecting a computer to the ICM. It comprises a USB:RS485 interface with a terminal block pre-wired with the ICM cable. An extra terminal block is provided for any customer wiring to external devices. An external DC adapter can be used to power the complete system, or if the computer is always connected during use, power can be taken directly from the USB cable. Note: Computer should have mains power applied at all times.

Detailed installation and usage instructions are provided in the separate product user guide.

# 10 Remote Control

The ICM can be controlled using the remote control facility included in the LPA-View software package, installed on a PC. Alternatively customers can use their own software running on a PC or PLC.

Since the ICM includes a built-in datalogging memory, operators can make use of the remote control facility in one of two ways:

- Direct Online Operation

The ICM is permanently connected to a computer while tests are carried out. The operator can set parameters, type a label and initiate the test. They can then monitor the progress of each test. Each test result is displayed and downloaded into the test database as it is completed.

- Disconnected Operation

Here the ICM operates as a stand alone item, performing tests on a schedule or under external command from a control system. If a permanent record of the results is needed, an operator can occasionally connect a computer and use LPA-View to download the accumulated test data.

## 10.1 Computer Connection

The connection is made using an RS485 adaptor connected to the PC. Either a USB:RS485 or a RS232:RS485 converter can be used, depending on the the interface available on the computer. The ICM-USBi is separately available as a pre-wired solution for USB (all modern laptops and PCs). Make the connection, start LPA-View running and then apply power to the ICM.



To access the Remote Device facility in LPA-View, press the Remote Control button on the toolbar.

The *Connect* dialogue will then appear.

The first time that this is done, the correct communications port (COM port) on the computer has to be selected, as detailed below.

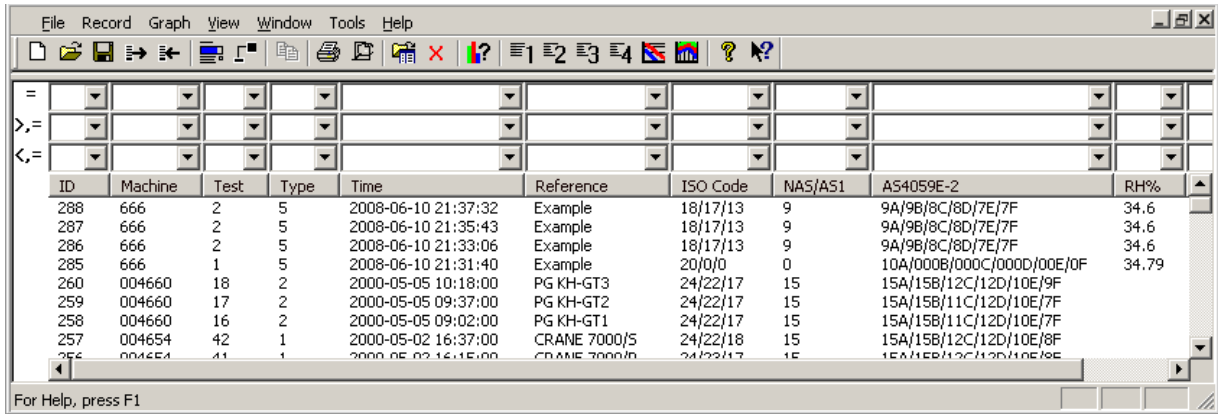

**Figure 1** LPA-View

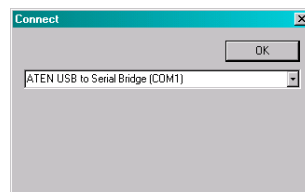
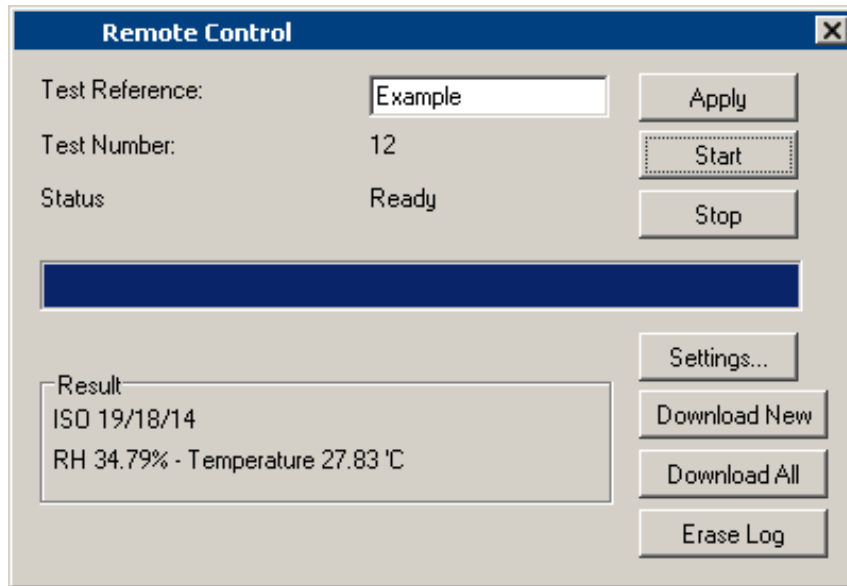

**Figure 2** The Connect dialogue

- The program scans the computer for available ports, and puts them in a list to choose from - this list is in the box above the Connect Button. Press the arrow on the right hand side of this box and choose the connection on your computer.
- All working communication ports of the computer are available for selection. Select the one used to connect the ICM, then press OK. If you are unsure which port is correct, the device name should be next to the COM port number. When communication has been established successfully, the remote control dialogue will appear. After a successful connection, the COM port will be remembered for next time and will appear preselected in the dialogue.

# 11 PC Software Operation

The *Remote Control* dialogue allows an operator to manually control the ICM from a PC, using the LPA-View software. It can also be used to download test results that have accumulated during autonomous (disconnected) operation.



**Figure 1** The Remote Control dialogue<sup>9</sup>

To perform a test, first optionally edit the *Test Reference* and press *Apply* to set the new value. This is a descriptive label which can be used to identify or group the test later (along with the test number and test time/date). An example would be a machine number or customer name. The *Test Reference* can be up to 15 characters in length.

When connected the ICM *status* should show "Ready". The operator can then press the *Start* button to begin the test. The *progress bar* shows how much of the test has been completed. The test can be abandoned at any time by pressing the *Stop* button. If the *Start* button is pressed during a test, then the current test is abandoned and a new one started.

When the test has finished, the *Result* area will display the contamination level in the set format and water content and temperature if 'W' option.

---

<sup>9</sup> Some items may be missing depending on the options fitted to the ICM.



After a test the *Test Number* is automatically incremented and the *status* of the test is displayed. If the status is *Ready* then the operator can press the *Start* button again to begin a new test. It is also possible to configure the ICM to *automatically* begin another test, after an optional delay. In this case the status will be *Testing* or *Waiting*.

The ICM incorporates a data logger, so previous test results can be downloaded into the test database using the *Download New* and *Download All* buttons. The difference between these is that *Download New* only transfers results that have never been downloaded before. *Download All* transfers all results that are stored in the ICM. *Erase Log* deletes the test results from the memory of the ICM.

When the user has finished operating the ICM the dialogue can be dismissed using the *close* control (the "X" at the top right corner of the dialogue) or by pressing the *Esc* key.

Pressing the *Settings...* button brings up the *Remote Device Settings* dialogue.

# 12 Settings

The ICM can be reconfigured<sup>10</sup> using the *Remote Device Settings* dialogue. This is normally done as part of the installation or commissioning process.

After making any changes, pressing the OK button will update the ICM with the new settings. Or press Cancel to leave the settings as they were.

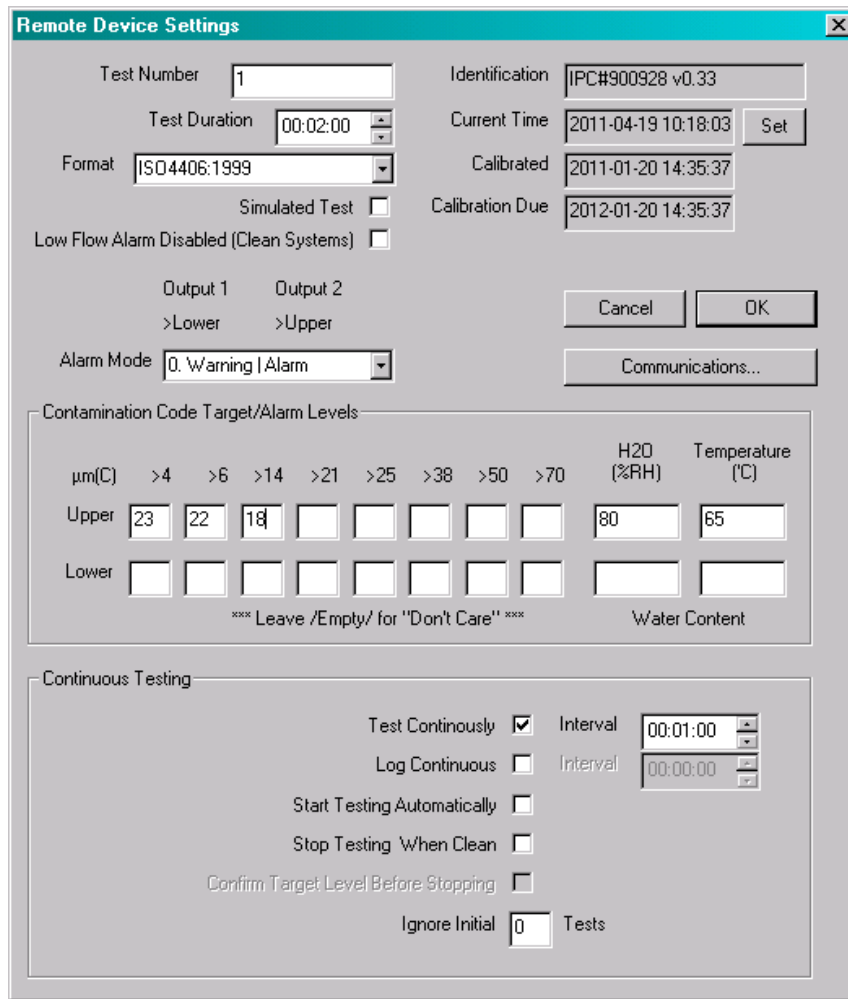

**Figure 1** Remote Device Settings dialogue<sup>11</sup>

<sup>10</sup> The ICM has been designed to be a very flexible product, so has a wide range of settings and operating modes. However the shipped defaults are suitable for most applications and many users can skip this section. Actual operation is straightforward even when advanced settings are used during initial configuration.

<sup>11</sup> Some items may be missing depending on the options fitted to the ICM.

## 12.1 General

Some general information about the connected ICM unit is available. The *Identification* shows the ICM serial number and software version. The serial number, together with the test timestamp, uniquely identify the test record. These two parameters are the ones used to avoid duplication of test records.

*Current Time* shows the time set on the ICM. It is important that this is correct since this is used to timestamp the tests. Pressing the *Set* button automatically synchronises the ICM time to that on the computer.

The *calibration* area displays the date last *Calibrated* and the next *Calibration Due* date.

## 12.2 Test Number

The *Test Number* can be used to help identify a test within a sequence. However it is automatically reset when the ICM is powered up, so instead relying on the timestamp (date and time of test) and test reference is preferred.

## 12.3 Test Duration

The length of the test is controlled by the *Test Duration*.

The factory set value of 2 minutes is suitable for most applications, but the user is free to set a different value. Shorter times will make the ICM more responsive to short-term fluctuations in contamination level. It will also result in less consistent results for the large particle sizes and clean systems, due to statistical fluctuations in the number of particles counted.

Longer tests will allow more "even" results in very clean systems and for the larger particle sizes, since there will be a larger total number of particles counted during the test. This means that any fluctuations have less of an effect on the test result.

## 12.4 Result Display

Use the selector to choose the preferred display *Format* (ISO, NAS etc). This selection is not just cosmetic since it also determines how the cleanliness alarm targets are to be interpreted, if these are used.

## 12.5 Simulated Test

This setting can be used when there is no flow available but communications need to be tested.

## 12.6 Low Flow Alarm Disabled (Clean Systems)

- The ICM uses the width of the pulse to derive flow, its flow output is only an indication, intended for installation guidance.
- It is worth reinforcing that the primary function of the product is to produce a measurement of cleanliness, and not act as a flow meter. If the unit produces a contamination measurement, then the flow rate is sufficient enough for it to do so.
- The ICM needs particles to pass through the flow cell to calculate flow, the dirtier the system is, the more statistically accurate the flow output becomes.
- Conversely, when placed on a very clean system it can have difficulty in working out the flow due to the very low number of particles passing through the flow cell. This will not effect the contamination measurement, but it is worth noting that a lower confidence or no indication at all on a clean system. If this is the case the tick box is available to allow a contamination reading.
- It may be necessary that the low flow indicator is turned off if filtration is below 10um.

## 12.7 Continuous Testing

In the *Continuous Testing* area are settings which control how the ICM decides when to perform and log a test. Selecting *Test Continuously* makes the ICM automatically repeat the test, according to the specified *Test Interval*. Setting an interval longer than the test duration results in the test being repeated upon each expiry of that interval. For example, setting a *Test Duration* of 1 minute, and a *Test Interval* of 10 minutes, results in a 1 minute test performed every 10 minutes. Setting the interval to a value less than the Test Duration (for example zero) results in a new test being started immediately a test finishes.

*Log Continuous* controls whether tests are logged during continuous testing. This is to avoid the test log being cluttered by potentially large numbers of unwanted test results. If *Log Continuous* is not selected, then only the "final" test in a sequence is logged (see Alarm Modes section and "Stop Testing When Clean" below).<sup>12</sup>

If continuous logging *is* used, then the *Log Interval* can be set to control the proportion of tests that are actually logged. For example the ICM could be set to test every 10 minutes, but only log a result hourly. The log interval, test interval and test duration are distinct parameters that work together to control the test and data logging. So that for example a test duration of 2 minutes, a test interval of 10 minutes, and a log interval of 1 hour could be set. This would result in 2 minute long tests, repeated every 10 minutes, with a test logged hourly.

*Start Testing Automatically* sets the ICM to begin a test soon after it is powered up. This is ideal for unattended systems.

*Stop Testing When Clean* is a feature intended for cleaning rigs or "filter trolley" type applications. The ICM continues testing until the fluid is "clean", at which point an alarm is signalled and testing stops.

*Confirm Target Level Before Stopping* This helps to ensure that a test sequence is not terminated too soon, when there are still a few large particles in the system. When selected, two successive "clean" results are needed before testing halts.

## 12.8 Alarms

The ICM has two switched "alarm" outputs that can be used to signal external equipment in various ways, according to the test results and the alarm settings. There is also a multi-colour front panel light which indicates how the result compares to the set alarm thresholds.

The alarm settings are comprehensive and flexible, allowing the ICM to be used in many different scenarios.

---

<sup>12</sup> This feature is intended for a "Filter Trolley" type application where system runs a pump until the oil is sufficiently clean. Typically only the final "clean" result requires logging.

## 12.8.1 Alarm LED

The front panel LED also indicates these alarm states to the operator (see section 4).

## 12.8.2 Alarm Levels

The various alarm thresholds are set in the *Contamination Code Target / Alarm Levels* area of the dialogue.

Contamination Code Target/Alarm Levels										
$\mu\text{m(C)}$	>4	>6	>14	>21	>25	>38	>50	>70	H2O (%RH)	Temperature (°C)
Upper	23	22	18						80	65
Lower										

\*\*\* Leave /Empty/ for "Don't Care" \*\*\*

Water Content

**Figure 2** ISO4406:1999 Alarm Levels

Alarms can be set on combinations of cleanliness codes, water content and temperature. The available codes, and their interpretation, vary according to the set test *Format*. For example it is possible to set a threshold of "NAS 11" or "ISO 18/16/15" or "AS4059E 8B-F", etc.

In general there are upper and lower limits that can be set for the cleanliness level, also for water content and temperature if applicable. An alarm, if enabled, will become active if *any* of the associated (upper/lower) limits are exceeded. However if a field is left empty (blank) this is interpreted as a "don't care" setting.

In the example Figure 2 the Upper Alarm is exceeded if the 4 $\mu\text{m}$  count is greater than ISO code 23, or the 6 $\mu\text{m}$  greater than ISO code 22, or the 14 $\mu\text{m}$  count greater than code 18, or the water content is greater than 80% RH, or the temperature is greater than 65°C. The lower alarm is never triggered since all the settings are empty.

### ISO4406:1999 Alarm Levels

ISO4406:1999 represents cleanliness using codes for the number of particles greater than 4, 6 and 14  $\mu\text{m}$ . These codes can be used as limits for the alarms by selecting

the ISO4406:1999 test *Format* and then entering values as required. As an extension to ISO4406:1999 it is also possible to specify codes for the other measured sizes too. If this is not needed then the entries can be left blank.

### NAS1638 Alarm Levels

Contamination Code Target/Alarm Levels									
	Basic Class	µm	5-15	15-25	25-50	50-10	100+	H2O (%RH)	Temperature (°C)
Upper	<input type="text" value="7"/>	<input type="text"/>	<input type="text"/>	<input type="text"/>	<input type="text"/>	<input type="text"/>	<input type="text"/>	<input type="text" value="80"/>	<input type="text" value="65"/>
Lower	<input type="text"/>	<input type="text"/>	<input type="text"/>	<input type="text"/>	<input type="text"/>	<input type="text"/>	<input type="text"/>	<input type="text"/>	<input type="text"/>
*** Leave /Empty/ for "Don't Care" ***								Water Content	

NAS1638 can be used by selecting this as the test *Format*. The headings and boxes for the available settings change appropriately. NAS1638 represents the overall cleanliness level as a single code, this being the highest of the individual codes generated for each defined particle size. Hence we have the option of setting a limit on this overall contamination class (the *Basic Class*), or we can set individual limits on any combination of the classes for the defined particle size ranges.

### AS4059E Table 2 Alarm Levels

Contamination Code Target/Alarm Levels									
	Basic Class	A	B	C	D	E	F	H2O (%RH)	Temperature (°C)
Upper	<input type="text" value="7"/>	<input type="text"/>	<input type="text"/>	<input type="text"/>	<input type="text"/>	<input type="text"/>	<input type="text"/>	<input type="text" value="80"/>	<input type="text" value="65"/>
Lower	<input type="text"/>	<input type="text"/>	<input type="text"/>	<input type="text"/>	<input type="text"/>	<input type="text"/>	<input type="text"/>	<input type="text"/>	<input type="text"/>
*** Leave /Empty/ for "Don't Care" ***								Water Content	

AS4059E Table 2 uses letters instead of numbers to indicate the particle size range, so the settings are labelled appropriately. The standard specifies ways to represent a cleanliness level using only a subset of the available particle sizes, for example B-F. The user can achieve this by only entering settings for the sizes desired, leaving the others empty. So a limit of AS4059 7B-F could be represented simply by entering a value of 7 for B,C,D,E and F.

### AS4059E Table 1 / ISO11218 Alarm Levels

Contamination Code		Target/Alarm Levels						H2O	Temperature
Basic	µm	5-15	15-25	25-50	50-100	>100	(%RH)	(°C)	
Class	µm(C)	6-14	14-21	21-38	38-70	>70			
Upper	7						80	65	
Lower									

\*\*\* Leave /Empty/ for "Don't Care" \*\*\*

Water Content

These two standards are similar except for terminology and reporting format. The actual numeric sizes and class thresholds are the same.

### 12.8.3 Alarm Mode

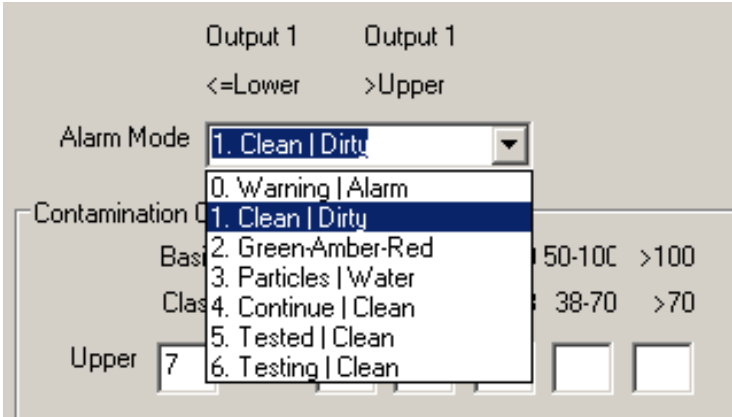

**Figure 3** Alarm Modes

The *Alarm Mode* sets the precise function of the two switched alarm outputs of the ICM.<sup>13 14</sup>

This allows the ICM to be used in a variety of situations. Note that the conditions under which the outputs are turned on are also displayed above the *Alarm Mode* selector, for each setting.

<sup>13</sup> Note that these outputs are distinct from the front panel LED, and that the set alarm mode does not affect the LED. The set alarm mode determines the function of the two switched outputs only. This setting and this entire section can be ignored if these outputs are unused, i.e. the user has not connected them to anything.

<sup>14</sup> New modes are occasionally added after a customer request, this means that modes may not all be implemented unless using the latest firmware revision.



## Alarm Mode 0: Warning-Alarm

---

	Output 1	Output 2
Turns on When	>Lower	>Upper
Intended Function	Warning	Alarm

---

This allows the ICM to switch external warning lights or alarms. Output 1 is the "Warning" output, switching on if any of the *Lower* limits are exceeded. Output 2 is the "Alarm" output, behaving similarly for the upper limit.

## Alarm Mode 1: Clean-Dirty

---

	Output 1	Output 2
Turns on When	$\leq$ Lower	>Upper
Intended Function	Clean	Dirty

---

This could be used in a cleaning system that attempts to maintain a cleanliness level by switching a pump on and off.

Output 1 is the "Clean" output, coming on when the result is less than or equal to the lower ("Clean") limit. This could be used to stop a cleaning pump.

Output 2 is the "Dirty" output, coming on when the result is greater than the upper ("Dirty") limit. This could be used to start the cleaning pump.

## Alarm Mode 2: Green-Amber-Red

---

	Output 1	Output 2
Turns on When	<Upper	>Lower
Intended Function	Green	Red

---

- This mode encodes the result in such a way that the internal alarm relays can be used to drive an *external remote* 3-colour LED indicator. This is a special type of LED containing both red and green emitters, which could be mounted in a control panel. This external LED will then turn green / amber / red according to the test result – in a similar way to the built-in one. Output 1 ("Green") is turned on when

the result is less than the upper limit. Output 2 ("Red") is turned on when the result is greater than the lower limit. If the result is in between, both outputs are turned on and the LED colour will be amber (i.e. a mixture of red and green light).

### Alarm Mode 3: Particles-Water<sup>15</sup>

	Output 1	Output 2
Turns on When	Cleanliness > Upper	Water > Upper
Turns off when	Cleanliness ≤ lower	Water ≤ lower
Intended Function	Cleanliness Alarm	Water Alarm

This is used when separate alarm outputs are needed for particles (cleanliness) and water content.

### Alarm Mode 4: Continue - Clean

	Output 1	Output 2
Turns on When	Testing	Cleanup Complete
Intended Function	Continue Testing	Cleanup complete

This is used for a "cleaning" application where a signal is needed to run a pump ("Continue Testing") and optionally operate an indicator ("Cleaning Complete").

*"Continuous testing" and "Stop Testing When Clean" must both be selected for this mode to operate.*

Output 1 then operates immediately so it can be used to switch on a pump. Testing continues until a clean result is obtained. Testing then stops. Output 1 is turned off and Output 2 turned on to indicate "Cleaning complete"

### Alarm Mode 5: Tested-not Clean

	Output 1	Output 2
--	----------	----------

<sup>15</sup> This mode is able to use both upper and lower limits such that the outputs have "hysteresis". If this is not desired then *both upper and lower limits should be set to the same value.*

Turns on When	Test Complete	>Lower
Intended Function	Test Complete Signal	"not clean" Signal

This is used when controlling tests from a PLC using switched outputs. The PLC gives a start signal, then monitors the "Test Complete" output. If the test has failed it can detect this with the "not clean" signal.

*“Continuous testing” should not be selected for this mode.*

### **Alarm Mode 6: Testing-not Clean**

	Output 1	Output 2
Turns on When	Testing	>Lower
Intended Function	Test in progress signal	"not clean" Signal

This is similar to mode 5 above. The difference is that output 1 is active during the test and turns off at test end.

*“Continuous testing” should not be selected for this mode.*

### **Alarm Mode 7... Customer Requested Modes**

Other alarm modes will be defined as and when customers request them.

# 13 Installation

Each ICM supplied consists of the following:

- ICM
- Calibration certificate
- LPA-View CD ROM, software package
- Pre-wired cable

Optional Equipment:

- Circular connector pre-wired with 3m cable
- ICM-RDU Remote display unit
- 500  $\mu\text{m}$  coarse screen filter
- ICM-FC1 Flow Control Valve
- ICM-USBi USB adaptor with pre-wired ICM cable

## 13.1 Installation Procedure

- Decide on tapping points in hydraulic circuit.
- Locate the unit mechanically and bolt to desired location using fixing holes provided. The ICM must be in a vertical orientation, with the oil flowing upwards through it.
- Wire back to junction box.
- Check flow in acceptable range. There needs to be a differential pressure placed across the ICM, such that a flow of fluid is generated within the range of the unit.
- If there is no suitable differential pressure available, then a flow controller will be needed. One solution is the ICM-FC1 which will accept a pressure from 4-400 bar, emitting a constant flow within the range of the ICM. This should be fitted to the drain side of the ICM (the top fitting).
- Fix mechanically.

- Connect hoses.
  - There must be no extra restriction placed in the drain hose. Do not have a pipe going to a restrictor to control flow. Any such restrictor must be mounted directly to the ICM drain fitting.<sup>16</sup>
  - Fluid flow must be from the bottom fitting to the top, following the direction of flow arrow on the product labelling i.e. the bottom fitting is the inlet and the top fitting is the outlet.
- Fit electrical connector, wire back to a junction box.

---

<sup>16</sup> This is because any length of pipe between the ICM and a downstream restrictor can act as an accumulator. Any pressure pulsations (for example from a pump) in the feed to the ICM are then translated into pulsations in flow rate, sometimes leading to flow reversals in time with the pulsations. If the flow is very low this can sweep the same particle backwards and forwards through the sensing volume multiple times, confusing the results.

# 14 Electrical Interface

Note: The separate ICM-USBproduct is available for those wishing to simply plug the ICM into a computer. This section is for those wishing to do their own wiring to the product.

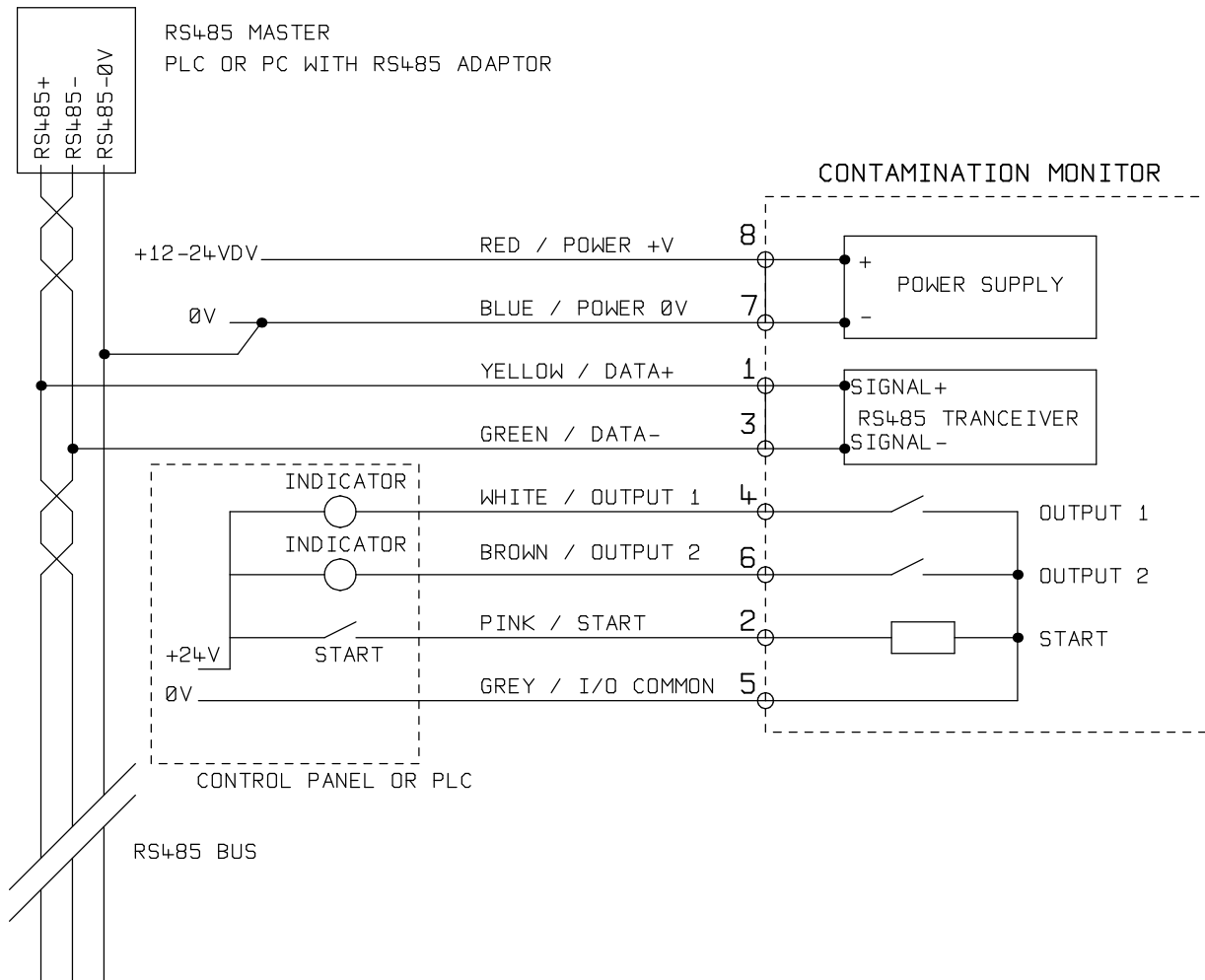

**Figure 1** External Wiring Example

In Figure 1 an example installation is shown.

## 14.1 DC Power

DC power is connected to pins 7 and 8 of the ICM circular connector (Red and Blue if using the pre-wired cable). All the other signals are optional.

Item	Minimum	Maximum
Voltage	9V DC	36V DC
Current		200mA

## 14.2 Serial Interface

An RS485 interface can optionally be connected to pins 1 and 3 (yellow and green). This can be a PLC running customer software, or a PC with a RS485 adaptor running the supplied LPA-View software. To provide a reference the RS485 0V connection should also be linked to the ICM 0V (as shown on the drawing).

The standard ICM control protocol is Modbus RTU. Modbus is a freely available open standard for industrial control. Adapters are available to interface to other industrial control buses. The standard LPA-View software from MP Filtri UK itself uses Modbus to communicate with the ICM, but it is also possible for customers to implement their own controllers – see chapter 18.

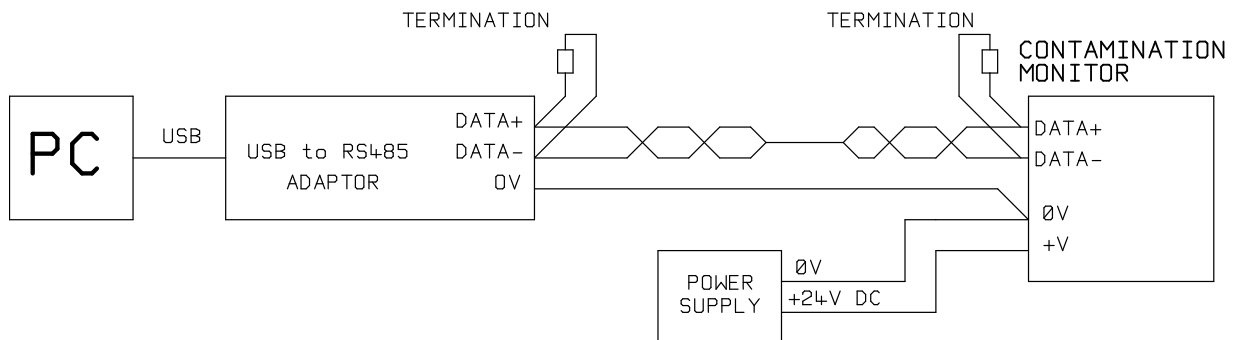

**Figure 2** PC Control Example

Figure 2 shows a single ICM linked to a PC, using a USB-RS485 adaptor. 100 Ohm termination resistors should be fitted as shown for long cables, for example over 10m. Twisted pair wiring should be used for any length over 2m.

Figure 3 shows how to connect two or more ICM devices to a multi-drop RS485 network. Any termination resistors should be fitted to the network cable ends only. Spurs off the main RS485 bus should be kept as short as possible, e.g. below 2m. Normally the pre-wired 3m cable available for the ICM would be used, with a junction box to connect to the RS485 trunk. Either individual DC supplies can be used to power each ICM, or a single supply run through the trunk cable.

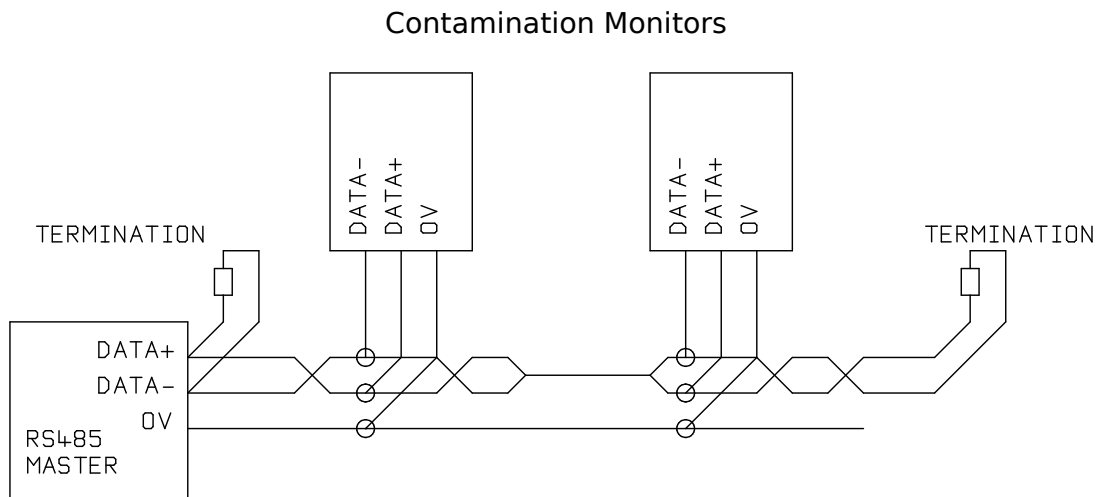

**Figure 3** Multi-Drop Network Example

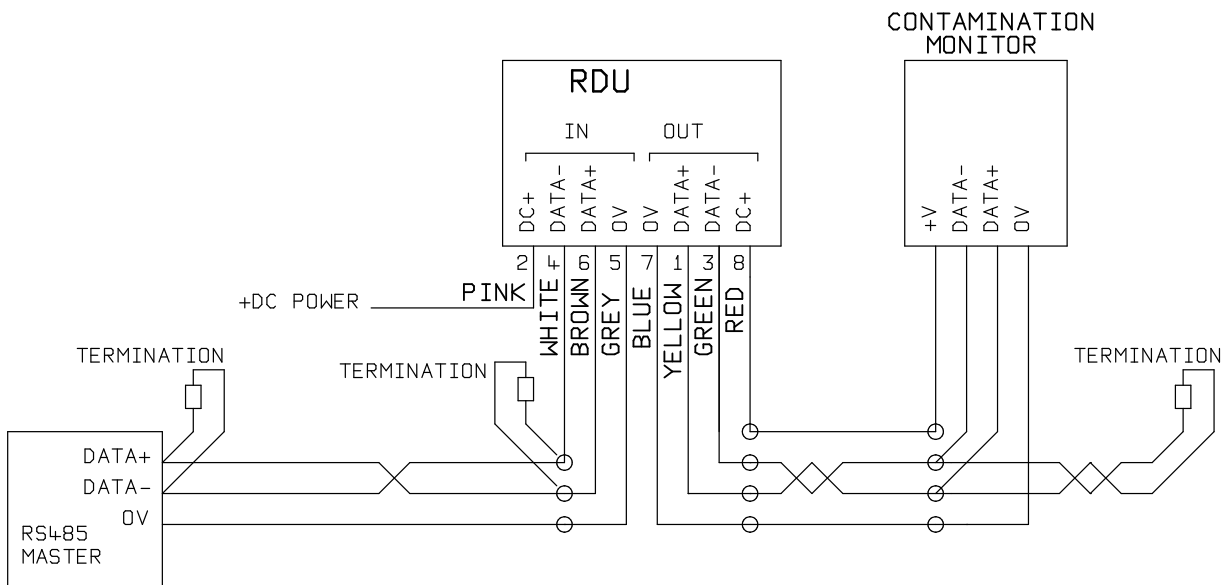

**Figure 4** Remote Display Unit Including PC Controller Example

Figure 4 shows how to connect the ICM-RDURemote Display Unit. The RDU is used when the ICM location is not convenient for an operator. It can control and monitor a remote ICM, as well as allowing an external controller to be connected to it (for data download, for example).



## 14.3 Switched Input and Output Signals

The ICM has one switched input and two switched outputs. These can be used instead of, or in addition to, the RS485 interface for command and control. The RS485 interface is more flexible but requires more software work if LPA-View is not used (e.g. control from a PLC). An alternative is to control the ICM via these switched signals, either from a PLC or using a manual switch and indicators.

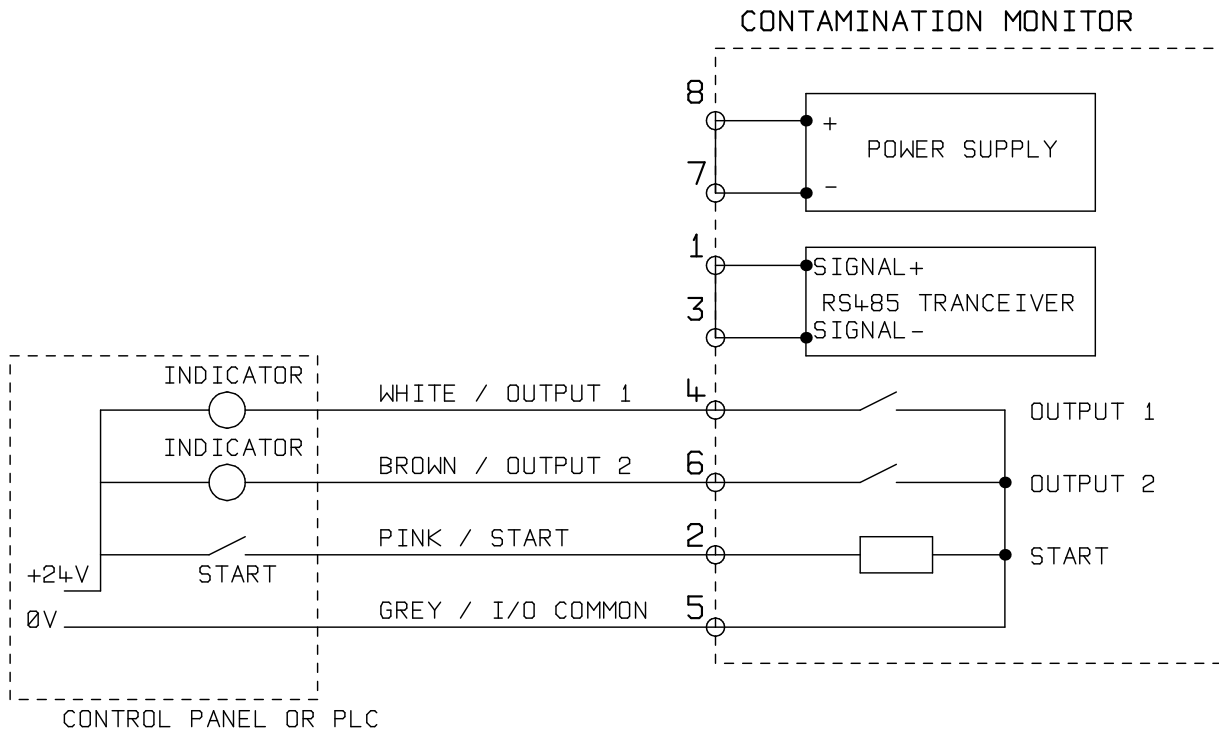

**Figure 5** Switched I/O Signals

In order to reduce wiring the input and outputs all connect together on one side (see Figure 5). However they are optically isolated from the rest of the system so can be used to switch unrelated signals.

## 14.4 Start Signal

The "start signal" is an opto-isolated input that can be used to start a test. This could be from a push button or a PLC output. The input accepts AC or DC signals, typically derived from the DC supply voltage. The exact function of this input is determined by the Test Mode setting (12.7).

Item	Minimum	Maximum
Voltage	9V DC	36V DC
Impedance	10k Ohms	

Other ways to start a test are:

- From the ICM front panel START button, if fitted (KKeyboard option).
- Via LPA-View or PLC Modbus command.
- Periodic automatic testing according to a programmed test mode.

## 14.5 Alarm Outputs

These are opto-isolated switches that can be used to signal external indicators, PLC inputs or other equipment (e.g. pump on/off control).

The exact function of these outputs is determined by the Alarm Mode setting (see 12.8.3).

The outputs are "voltage free" contacts that can switch AC or DC signals up to 36V nominal (60V absolute maximum peak voltage).

Item	Minimum	Maximum
Voltage		36V DC
Current		0.5A

# 15 Hydraulic Connection

## 1 High or Low Pressure Parallel Connection

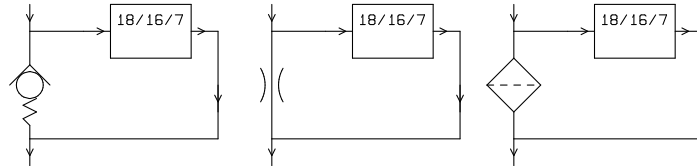

**Figure 1** ICM working pressure generated by hydraulic component.

## 2 Low Pressure, Off-Line Operation

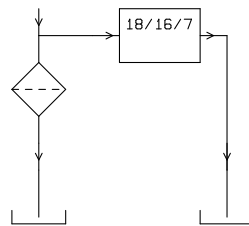

**Figure 2** ICM working pressure generated by hydraulic component.

## 3 Very Low Flow Systems

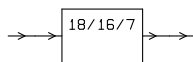

**Figure 3** Entire system flow rate is within the range of the ICM.

## 15.1 Flow Rate

### 15.1.1 Summary

For the majority of systems, a differential pressure of a few Bar will generate an in-range flow for an ICM connected using two 1.5 meter lengths of Mini-mess

hose. The required differential pressure can be obtained by taking advantage of an existing pressure drop within the system. Alternatively one can be created by inserting a check valve. The ICM can then be connected across this differential pressure source.

### 15.1.2 Detailed Calculations

In general the flow rate of fluid through the ICM needs to be kept within the range of the unit (see hydraulic specification 3.2). The ICM measures the flow during operation, so this can be used to check that the flow is correct.

A flow that is out of range will be indicated by a fault code (see 16.1).

*Results taken with out-of-range flows are not logged.*

The flow is entirely generated by the differential pressure between the ends of the pipes used to connect the ICM. The pressure needed to generate an in-range flow can be estimated by assuming a target flow, and determining the resulting pressure drop across the ICM and connection piping. Use the graph 4 to lookup the ICM pressure drop, and manufacturers data to lookup the piping pressure drop at the desired flow. The sum of these two pressures is the pressure needed.

The user connects the ICM between two points in the hydraulic circuit, that have this pressure difference.

In order to use the graph:

- Determine the working viscosity of the fluid, e.g. 30 cSt.
- Decide on a desired flow rate. 200ml/minute is normally used since this is in the middle of the ICM flow range. But 100ml/minute is also suitable and uses less oil.
- Use the graph 4 to look up the pressure drop, across the ICM ports, at this flow rate and viscosity. E.g. at 30cSt and 200ml/minute, this is 0.4 Bar. The maximum and minimum allowed differential pressures can also be determined using the 400ml/min and 20ml/min lines, respectively.
- Determine the additional pressure drop caused by the piping used to connect the ICM. This may be negligible for 1/4 inch piping and over, but is very important

for "Mini-mess" hoses. This information can be found in the manufacturers catalogues. In the case of Mini-mess hoses, at 30 cSt these have a pressure drop of around 10 Bar per meter per lpm of flow. So a 2m total hose length would add a pressure drop of  $2 \times 10 \times 0.2 = 4$  Bar. (So in this case the pressure-flow relationship is mainly dependent on hose resistance.)

- Add the ICM pressure drop to that of the hoses, e.g.  $4 + 0.4 = 4.4$  Bar.

When the required pressure drop has been found:

- See the figures at the start of this section for examples of where the ICM could be connected.
- If there is a pair of connections in the hydraulic circuit that operates with a differential pressure near to that calculated, then the ICM can be connected there.
- Alternatively, create the pressure drop by modifying the hydraulic system. For example, insert a check-valve in the circuit with a 4 bar spring.<sup>17</sup> The "component" could also be a filter, a restrictor or even a piece of piping if it has a suitable pressure drop across it.
- If none of these options is feasible, then an active flow controller will likely be needed, see 15.3.
- Otherwise connect the ICM across the points identified, taking care to maintain an upward flow of oil through the unit (this reduces trapped air).

Of course in a real system the pressure and viscosity will vary with temperature and operating conditions. But since the working flow range of the ICM is very wide, this should not be a problem provided it remains within range. On the graph the area between upper and lower lines represents the usable operating region for the ICM, with the middle line being ideal. The differential pressure and the viscosity can vary from the ideal, provided the system stays within the upper and lower lines. This ensures the flow stays within the working range of 20 - 400 ml/min. It can be seen that the unit will accommodate a 20:1 variation in either viscosity or differential pressure during operation.

---

<sup>17</sup> In fact the ICM will work perfectly well at a lower flow, for example 100ml/minute, in which case a 2 Bar check-valve could be used.

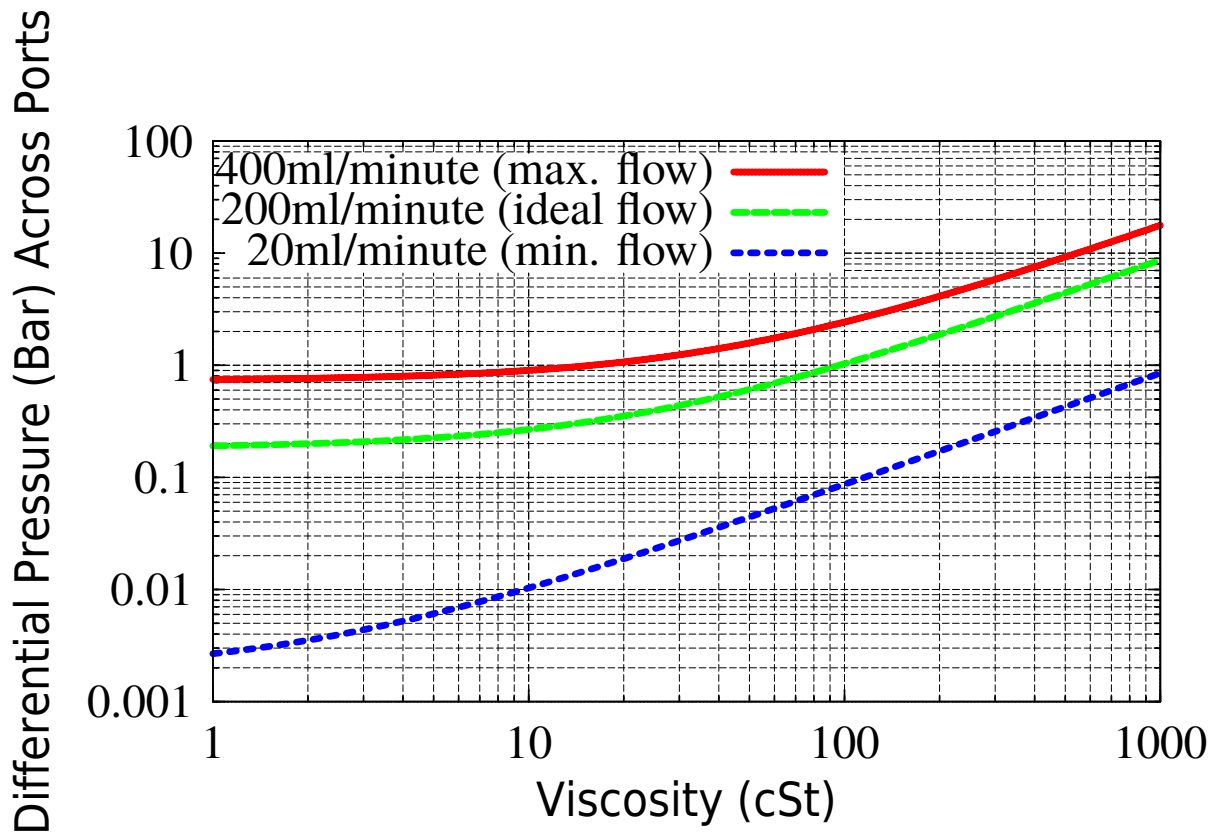

**Figure 4** Differential Pressure vs Fluid Viscosity, for various flow rates

## 15.2 Manual Flow Control

Another possibility is to fit a simple manual flow control (flow restrictor) to the outlet of the ICM.

- This should only be done where the available pressure is less than twice the maximum value calculated. This is because the small orifice size needed to control the flow from a pressure larger than this has a risk of blockage.
- The flow controller must be fitted to the outlet only. If fitted to the inlet it will have a filtering effect.
- The flow controller must be fitted directly to the ICM outlet port.

## 15.3 Active Flow Control

This is only needed for High Pressure, Off-Line Operation.

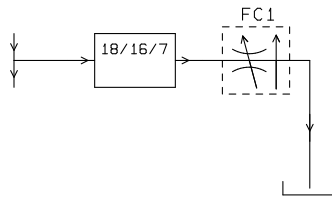

**Figure 5** ICM flow actively regulated.

A pressure compensated flow control valve is fitted to the ICM drain outlet. This maintains a constant flow rate even with a varying inlet pressure (provided this pressure stays above a minimum working value). A suitable valve is the ICM-FC1 (see 2.1.2), but other ones can be used too.

# 16 Fault Finding

## 16.1 LED Flashing / Fault Codes

The ICM front panel led indicates a fault by a number of white flashes, with a red background. The number of flashes indicates the fault code:

1. *Optical* - An optical fault could indicate LED failure or blockage of the optical path. Try flushing with Petroleum Ether, or return to MP Filtri UK.
2. *Low Flow* - The ICM estimates the flow by measuring the transition time of the particles. The Low Flow warning indicates that the flow rate is below the minimum recommended level.<sup>18</sup>
3. *High Flow* - The flow rate is above the maximum recommended level. This will degrade the accuracy of the particle counts.
4. *Logging* - Fault with data logging memory.
5. *Water Sensor* - Fault with the water sensor.

## 16.2 Test Status

The status is shown on the ICM screen. This contains a number indicating the current state of the ICM, according to Table 1. This allows a system to remotely monitor the ICM operation, if desired, allowing more specific diagnostics.<sup>19</sup>

---

<sup>18</sup> The unit will still work but may be more susceptible to errors caused by pressure fluctuations. This warning can also come on when there are no particles whatsoever detected, i.e. the fluid is totally "clean". In this case the correct result e.g. 0/0/0 is still generated.

<sup>19</sup> However the fault conditions are also indicated on the front panel LED, while "No Result" in the case of a fault is indicated using special result values as previously described.

<sup>20</sup> User has not set tests to occur automatically.

<sup>21</sup> User has set a non-zero test interval.

<sup>22</sup> Or fluid is totally clean (no particle counts). Flow alarm can be turned off by user if this is a problem, for example cleaning rigs.



Value	Function	Comment
0	NOT READY	Unit is powering-up, or there is some problem
1	READY	Ready to start a test <sup>20</sup>
2	TESTING	Test in progress
3	WAITING	Waiting between tests <sup>21</sup>
128	FAULT OPTICAL	LED failure / sensor blocked / filled with air
129	FAULT FLOW LOW	Flow too low for reliable test <sup>22</sup>
130	FAULT FLOW HIGH	Flow too high for reliable test
131	FAULT LOGGING	Fault with data logging
132	FAULT WATER SENSOR	Water sensor failure

**Table 1** The TEST STATUS Register

## 16.3 Other Faults

*Unexpected results obtained from sample*      Check that the Mini-mess hose has been fully connected at both the system and ICM ends.  
 Confirm that the flow through the ICM is within the range of the unit.  
 High water / aeration levels.

*Remote Device dialogue not responding to buttons being pressed.*      Check that correct COM port has been selected in the Remote Device dialogue.  
 Disconnect power supply to ICM and then reconnect it.

If the ICM has been subjected to excessive contamination and a blockage is suspected, a flush with a suitable solvent may clear the blockage.

The standard ICM is fitted with Viton seals, so Petroleum Ether or Iso Propyl Alcohol may be used for this purpose, in conjunction with the MP Filtri UK Bottle Sampling Unit. See flushing guidelines on supplied product CD.

***DO NOT USE ACETONE***

# 17 Cycle Time and Flow Rate Considerations

The set *Test Duration* is the amount of time for which particle counts are accumulated, before the test result is updated. The default of 120 seconds is likely to be suitable for most applications. However it is possible to set other values.

A shorter time enables the unit to respond more quickly to variations in cleanliness. This may be desired in order to reduce the product test time in a production line situation.

A longer test time enables the unit to average out variations in cleanliness and produce a more stable result. This is especially true for the larger particle sizes. In clean systems there are very few of these, so a large amount of fluid needs to be sampled in order to count a statistically significant number.

Another factor is the flow rate. This can be traded off with cycle time, since a higher flow allows the same amount of fluid to be sampled in a shorter time.

*"Very Clean" Systems* – Longer test times / higher flows needed.

*"Normal" or "Dirty" Systems* – Shorter test times or lower flows are acceptable.

This relationship is shown in Figure 1.

---

<sup>23</sup> This means >20 particles counted as per ISO 4406:1999

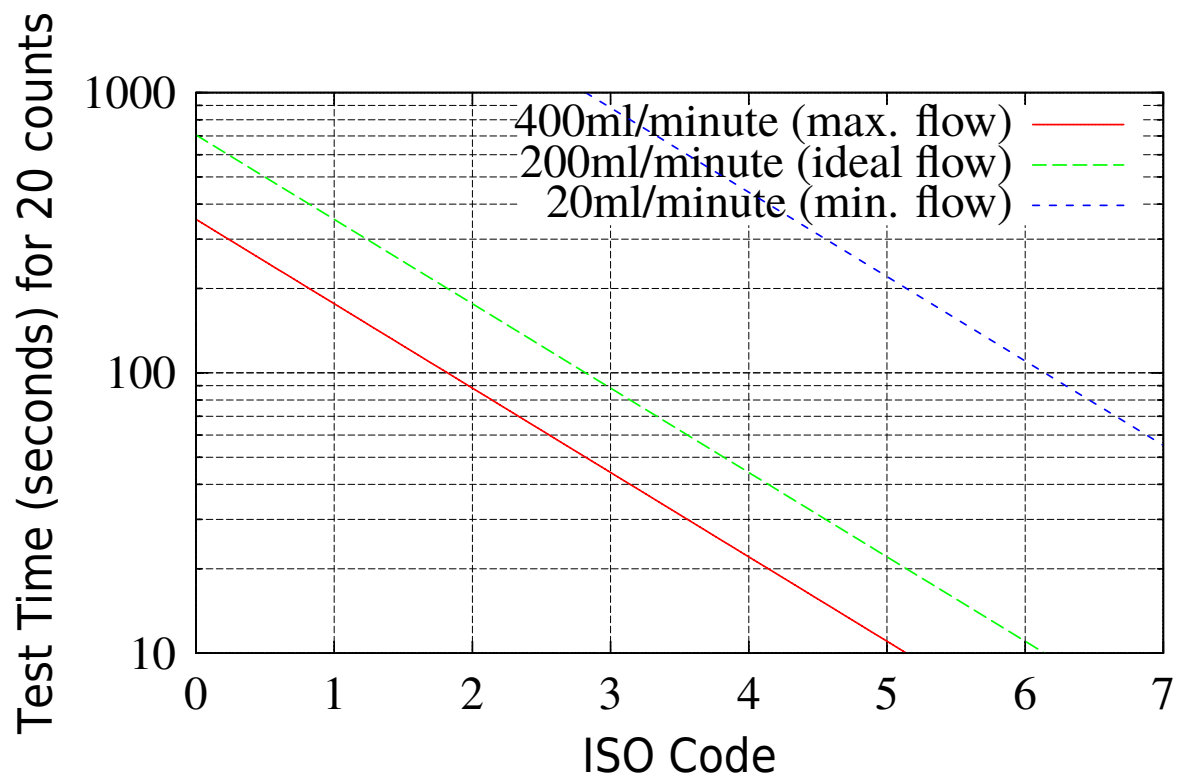

**Figure 1** Test Time needed for Reliable Indication<sup>23</sup> by ISO code

# 18 Modbus Programming

The ICM can be controlled via commands on its serial (RS485) interface, using the Modbus RTU protocol. It is possible to control every aspect and setting of the ICM, as is done by the MP Filtri UK LPA-View control software. All results and counts are available in all supported formats. One scenario is to use LPA-View to initially configure the ICM, then the customer-written software only has to read the test results. This could be used to integrate the ICM measurements with a general machine control, vehicle control or factory monitoring system.

Customers wishing to implement their own modbus controller software will need to refer to the full ICM Modbus Programming Manual – however a simple example is given here.

## 18.1 Reading the Result Codes

The simplest arrangement is to configure the ICM to test continuously, with a set interval between tests. For example a *Test Duration* of 2 minutes and a *Test Interval* of 10 minutes. The *Start Testing Automatically* selection can be used so that the unit does not require a start signal.

Then, the most recent test results can be read from the appropriate Modbus Registers.

---

Register	Function
56	4 $\mu$ m(C) Result Code
57	6 $\mu$ m(C) Result Code
58	14 $\mu$ m(C) Result Code

---



# Measuring Water in Hydraulic and Lubricating Fluids

*From North Notts Fluid Power Centre*

In mineral oils and non aqueous fire resistant fluids water is undesirable. Mineral oil usually has a water content of 50-300 ppm which it can support without adverse consequences.

Once the water content exceeds about 500ppm the oil starts to appear hazy. Above this level there is a danger of free water accumulating in the system in areas of low flow. This can lead to corrosion and accelerated wear. Similarly, fire resistant fluids have a natural water content which may be different to mineral oils.

## Saturation Levels

Since the effects of free (also emulsified) water is more harmful than those of dissolved water, water levels should remain well below the saturation point. However, even water in solution can cause damage and therefore every reasonable effort should be made to keep saturation levels as low as possible. There is no such thing as too little water. As a guideline, we recommend maintaining saturation levels below 50% in all equipment.

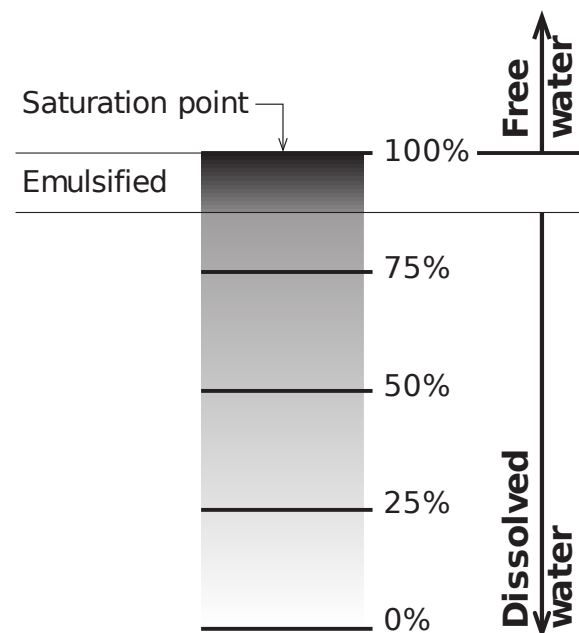

### Typical Water Saturation Levels For New Oils

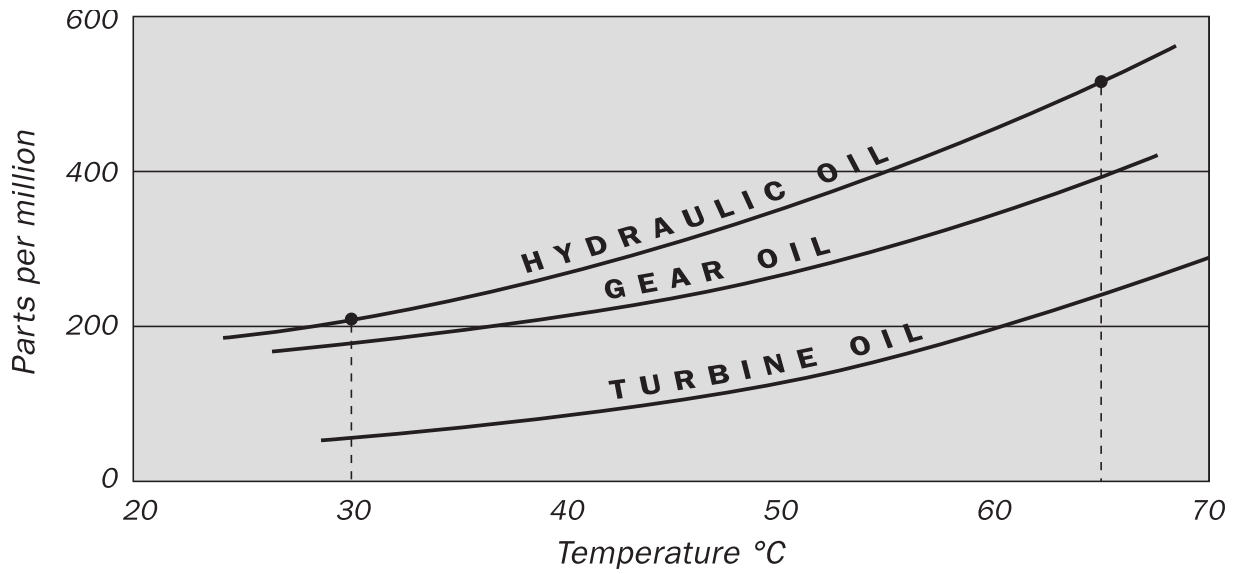

**Figure I**

Examples: Hydraulic oil @ 30°C = 200ppm = 100% saturation  
Hydraulic oil @ 65°C = 500ppm = 100% saturation



## ISO4406:1999 Cleanliness Code System

The International Standards Organization standard ISO 4406:1999 is the preferred method of quoting the number of solid contaminant particles in a sample.

The code is constructed from the combination of three scale numbers selected from the following table.

The *first* scale number represents the number of particles in a millilitre sample of the fluid that are larger than 4  $\mu\text{m}(\text{c})$ .

The *second* number represents the number of particles larger than 6  $\mu\text{m}(\text{c})$ .

The *third* represents the number of particles that are larger than 14  $\mu\text{m}(\text{c})$

<i>Number of Particles per mL</i>		<i>Scale No.</i>
<i>More than</i>	<i>Up to and including</i>	
2.5M	-	> 28
1.3M	2.5M	28
640k	1.3M	27
320k	640k	26
160k	320k	25
80k	160k	24
40k	80k	23
20k	40k	22
10k	20k	21
5000	10k	20
2500	5000	19
1300	2500	18
640	1300	17
320	640	16
160	320	15
80	160	14
40	80	13
20	40	12
10	20	11
5	10	10
2.5	5.0	9
1.3	2.5	8
0.64	1.3	7
0.32	0.64	6
0.16	0.32	5
0.08	0.16	4
0.04	0.08	3
0.02	0.04	2
0.01	0.02	1
0.0	0.01	0

## APPENDIX B

Microscope counting examines the particles differently to APCs and the code is given with two scale numbers only. These are at 5  $\mu\text{m}$  and 15  $\mu\text{m}$  equivalent to the 6  $\mu\text{m(c)}$  and 14  $\mu\text{m(c)}$  of the APCs.

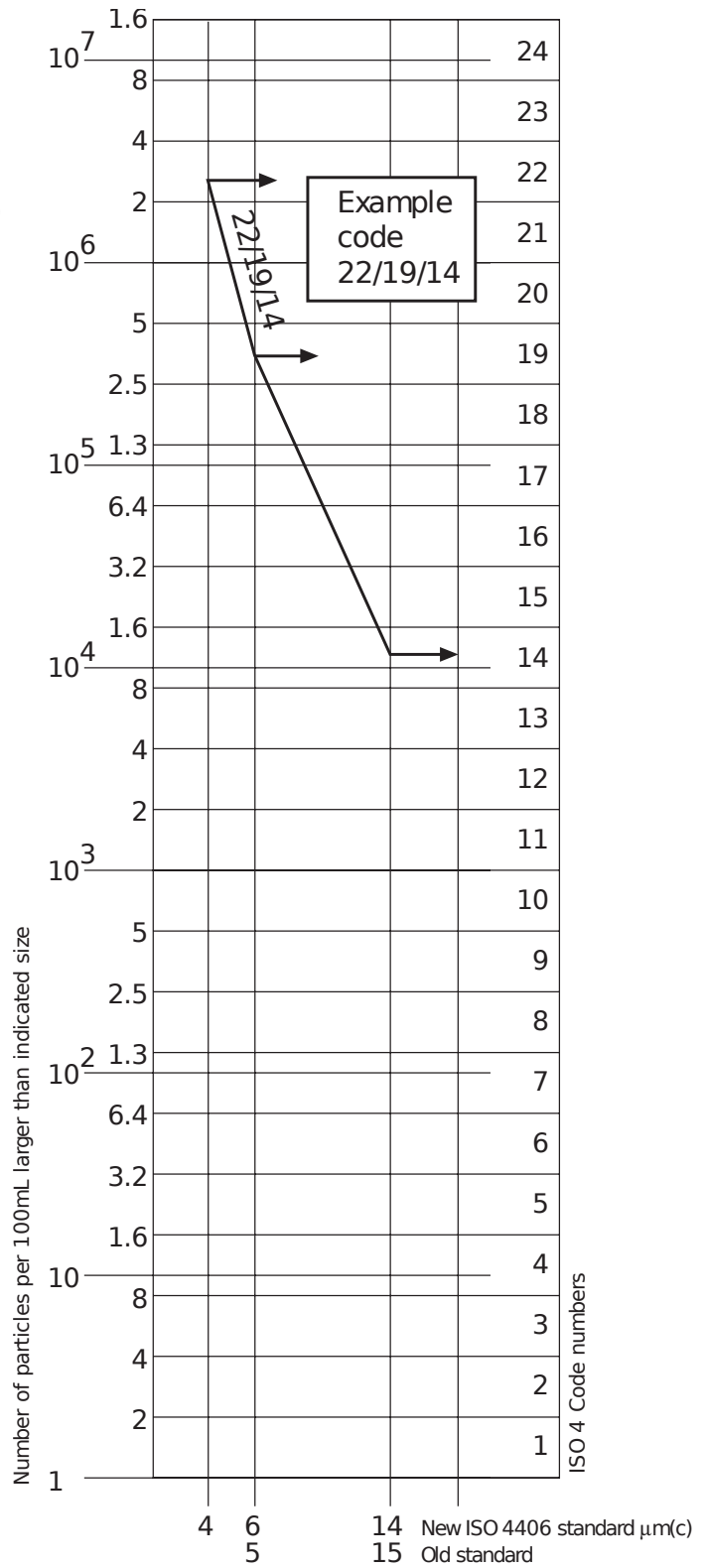

## NAS1638 Cleanliness Code System

The NAS system was originally developed in 1964 to define contamination classes for the contamination contained within aircraft components. The application of this standard was extended to industrial hydraulic systems simply because nothing else existed at the time. The coding system defines the maximum numbers permitted of 100ml volume at various size intervals (differential counts) rather than using cumulative counts as in ISO 4406:1999. Although there is no guidance given in the standard on how to quote the levels, most industrial users quote a single code which is the highest recorded in all sizes and this convention is used on the ICM software.

	00	0	1	2	3	4	5	6	7	8	9	10	11	12
<b>5-15</b>	125	250	500	1000	2000	4000	8000	16000	32000	64000	128000	256000	512000	1024000
<b>15-25</b>	22	44	89	178	356	712	1425	2850	5700	11400	22800	45600	91200	182400
<b>25-50</b>	4	8	16	32	63	126	253	506	1012	2025	4050	8100	16200	32400
<b>50-100</b>	1	2	3	6	11	22	45	90	180	360	720	1440	2880	5760
<b>Over 100</b>	0	0	1	1	2	4	8	16	32	64	128	256	512	1024

**Figure I** CONTAMINATION LEVEL CLASSES  
according to NAS1638 (January 1964).

The contamination classes are defined by a number (from 00 to 12) which indicates the maximum number of particles per 100 ml, counted on a differential basis, in a given size bracket.

## SAE AS4059 REV.E Cleanliness Classification For Hydraulic Fluids<sup>XXIV</sup>

This SAE Aerospace Standard (AS) defines cleanliness levels for particulate contamination of hydraulic fluids and includes methods of reporting data relating to the contamination levels. Tables 1 and 2 below provide the Maximum Contamination Limits (Particles/100ml) of differential and cumulative particle counts respectively for counts obtained by an automatic particle counter, e.g. ICM.

Size range $\mu\text{m(c)}$ :	6 - 14	14 - 21	21 - 38	38 - 70	>70
Class					
00	125	22	4	1	0
0	250	44	8	2	0
1	500	89	16	3	1
2	1,000	178	32	6	1
3	2,000	356	63	11	2
4	4,000	712	126	22	4
5	8,000	1,425	253	45	8
6	16,000	2,850	506	90	16
7	32,000	5,700	1,012	180	32
8	64,000	11,400	2,025	360	64
9	128,000	22,800	4,050	720	128
10	256,000	45,600	8,100	1,440	256
11	512,000	91,200	16,200	2,880	512
12	1,024,000	182,400	32,400	5,760	1,024

**Table 1 AS4059E Table 1** - Cleanliness Classes for Differential Particle Counts

<sup>XXIV</sup> The information reproduced on this and the previous page is a brief extract from SAE AS4059 Rev.E, revised in May 2005. For further details and explanations refer to the full Standard.

Size $\mu\text{m(c)}$	>4	>6	>14	>21	>38	>70
Size Code	A	B	C	D	E	F
Classes						
000	195	76	14	3	1	0
00	390	152	27	5	1	0
0	780	304	54	10	2	0
1	1,560	609	109	20	4	1
2	3,120	1,217	217	39	7	1
3	6,250	2,432	432	76	13	2
4	12,500	4,864	864	152	26	4
5	25,000	9,731	1,731	306	53	8
6	50,000	19,462	3,462	612	106	16
7	100,000	38,924	6,924	1,224	212	32
8	200,000	77,849	13,849	2,449	424	64
9	400,000	155,698	27,698	4,898	848	128
10	800,000	311,396	55,396	9,796	1,696	256
11	1,600,000	622,792	110,792	19,592	3,392	512
12	3,200,000	1,245,584	221,584	39,184	6,784	1,024

**Table II AS4059E Table 2** - Cleanliness Classes for Cumulative Particle Counts

## Recommendations

<i>Unit</i>	<i>Type</i>	<i>ISO 4406:1999 Code</i>
<b><i>PUMP</i></b>	Piston (slow speed, in-line)	22/20/16
	Piston (high speed, variable)	17/15/13
	Gear	19/17/15
	Vane	18/16/14
<b><i>MOTOR</i></b>	Axial piston	18/16/13
	Radial piston	19/17/13
	Gear	20/18/15
	Vane	19/17/14
<b><i>VALVE</i></b>	Directional (solenoid)	20/18/15
	Pressure control (modulating)	19/17/14
	Flow control	19/17/14
	Check valve	20/18/15
	Cartridge valve	20/18/15
	Proportional	18/16/13
	Servo-valve	16/14/11
<b><i>ACTUATOR</i></b>		20/18/15

**Table I** Typical Manufacturers Recommendations for Component Cleanliness (ISO 4406:1999)<sup>XXV</sup>

Most component manufacturers know the proportionate effect that increased dirt level has on the performance of their components and issue maximum permissible contamination levels. They state that operating components on fluids which are cleaner than those stated will increase life. However, the diversity of hydraulic systems in terms of pressure, duty cycles, environments, lubrication required, contaminant types, etc, makes it almost impossible to predict the components service life over and above that which can be reasonably expected. Furthermore, without

<sup>XXV</sup> It should be noted that the recommendations made in this table should be viewed as starting levels and may have to be modified in light of operational experiences or user requirements.

the benefits of significant research material and the existence of standard contaminant sensitivity tests, manufacturers who publish recommendations that are cleaner than competitors may be viewed as having a more sensitive product.

Hence there may be a possible source of conflicting information when comparing cleanliness levels recommended from different sources.

The table gives a selection of maximum contamination levels that are typically issued by component manufacturers. These relate to the use of the correct viscosity mineral fluid. An even cleaner level may be needed if the operation is severe, such as high frequency fluctuations in loading, high temperature or high failure risk.

## Hydraulic System Target Cleanliness Levels

Where a hydraulic system user has been able to check cleanliness levels over a considerable period, the acceptability, or otherwise, of those levels can be verified. Thus if no failures have occurred, the average level measured may well be one which could be made a bench mark. However, such a level may have to be modified if the conditions change, or if specific contaminant-sensitive components are added to the system. The demand for greater reliability may also necessitate an improved cleanliness level.

The level of acceptability depends on three features:

- the contamination sensitivity of the components
- the operational conditions of the system
- the required reliability and life expectancy

Contamination Codes ISO 4406:1999			Corresponding Codes NAS 1638	Recommended Filtration Degree	Typical Applications
4 $\mu\text{m(c)}$	6 $\mu\text{m(c)}$	14 $\mu\text{m(c)}$		Bx200	
14	12	9	3	3	High precision and laboratory servo-systems
17	15	11	6	3-6	Robotic and servo-systems
18	16	13	7	10-12	Very sensitive - high reliability systems
20	18	14	9	12-15	Sensitive - reliable systems
21	19	16	10	15-25	General equipment of limited reliability
23	21	18	12	25-40	Low - pressure equipment not in continuous service



The table above is a guide to the recommended filtration level for various hydraulic components, together with typical target system cleanliness levels.

## **New ISO Medium Test Dust and its effect on ISO Contamination Control Standards**

When General Motors gave advance warning to the International Standards Organization (ISO) that it was intending to stop the production of AC Fine Test Dust (ACFTD), work commenced immediately on finding an improved replacement dust. ACFTD was used extensively within the fluid power and automotive industries for calibrating Automatic Particle Counters (APCs) and for the testing of components.

APCs are used for testing oil filters, and also for contaminant sensitivity testing of hydraulic components. For 25 years, APCs have been the main stay in the measurement of solid particles in hydraulic fluids. The growth in demand for measuring fluid cleanliness in a variety of industrial processes, including fluid power, has resulted in APCs moving from the laboratory environment out into the factory. In fact, they are now a critical part of many production processes. It is therefore essential that the data they provide is both accurate and consistent.

### **Calibration**

ACFTD has been used as an artificial contaminant since the 1960s and its original particle size distribution was determined using an optical microscope. This particle size distribution subsequently formed the basis of ISO 4402, the method for calibrating APCs. Due to the limitations of that method of measurement, the particle size distribution was questioned below about 5 $\mu$ m. It was also not traceable to any national standard of measurement - a critical requirement for today's quality management systems.

There was also an absence of formal controls over the distribution of the test dust, and batch-to-batch variability was much greater than is acceptable nowadays.

ISO therefore defined the requirements for the replacement for ACFTD and asked the National Institute of Standards and Technology (NIST) in the USA to produce a standard, traceable reference material. The new dust's particle size distribution has been accurately determined with the aid of modern scanning electron microscope and image analysis techniques.

## New Test Dust Benefits

The new ISO Medium Test Dust (ISO MTD) consists of similar materials to the old ACFTD, but to minimize particle counting errors, it is of a slightly coarser grade because ACFTD included too many particles smaller than 5µm which gave problems during testing.

ISO MTD is produced to a standard distribution and stringent quality control procedures, thereby ensuring excellent batch-to-batch repeatability. These procedures, combined with a revised ISO APC calibration method give:

- A traceable and controlled reference test dust with greatly reduced variation in particle size distribution. This gives the trace-ability required by ISO 9000, QS9000 and similar quality management systems.
- A procedure for determining the performance of APCs so that minimum acceptable levels can be set by the user.
- Improved calibration techniques and procedures.
- More accurate calibration.
- Improved levels of particle count reproducibility with different equipment.
- More accurate and consistent filter test results.

## Effect on Industry

The introduction of ISO MTD has necessitated changes to certain ISO standards.

The standards affected include:

- |               |   |
|---------------|---|
| ISO 4402:1991 | Hydraulic fluid power<br>Calibration of liquid automatic particle counters.                                     |
| ISO 4406:1987 | Hydraulic fluid power<br>Code for defining the level of contamination by solid particles.                       |
| ISO 4572:1981 | Hydraulic fluid power – Filters<br>Multi-pass method for evaluating filtration performance of a filter element. |

## APPENDIX G

In order that users are not confused by the changes to these standards, particularly by reference to them in technical literature, ISO is updating 4402 to ISO 11171, and 4572 to ISO 16889.

Two standards which concern our industry are the ISO 4406 coding system and the new ISO 16889 Multi-pass test. As APCs will henceforth count particles more accurately, there will now be a change in the way sizes are labelled.

In the new ISO 4406:1999, new calibration sizes are used to give the same cleanliness codes as the 'old' calibration sizes of 5 and 15  $\mu\text{m}$ . In this way, there will be no necessity to change any system cleanliness specifications. It is proposed that the cleanliness codes (for APCs) will be formed from three<sup>XXVI</sup> particle counts at 4, 6 and 14  $\mu\text{m}$ , with 6 and 14  $\mu\text{m}$  corresponding very closely to the previous 5 and 15  $\mu\text{m}$  measurements. This will ensure consistency in data reporting.

As the counts derived by microscope counting methods are not affected, the particle sizes used for microscopy will remain unchanged (i.e. at 5 and 15  $\mu\text{m}$ ).

To clarify matters still further, ISO standards written around the new test dust will utilize a new identifier, '(c)'. Hence  $\mu\text{m}$  sizes according to the new ISO 11171 will be expressed as ' $\mu\text{m}(c)$ ' and Beta ratios according to ISO 16889 will be expressed as 'Bx(c)', e.g. 'B5(c)'.

However, it must be stressed that the only real effect users will experience will be the improved accuracy in particle counts - there will be no change in the performance of filters, nor in the ISO cleanliness levels that they will achieve.

The following charts shows the correlation between the old ACFTD and the new ISO MTD.

The ICM is calibrated with ISO Medium Test Dust (to ISO 11171). The correlation between particle sizes and the ACFTD (old standard) to the ISO MTD (new standard) is as follows :

ACFTD	<1	5	15	25	30	50	75	100
ISO MTD	4	6	14	21	25	38	50 <sup>XXVII</sup>	70 <sup>XXVIII</sup>

---

<sup>XXVI</sup> The option of quoting just two counts of 6 $\mu\text{m}$  and 14 $\mu\text{m}$  for APCs remains.

<sup>XXVII</sup> Not verified by NIST

<sup>XXVIII</sup> acftd

## Correlation

The table shows the correlation between Particle Sizes Obtained using ACFTD (ISO 4402:1991) and NIST (ISO 11171) Calibration Methods

*This table is only a guideline. The exact relationship between ACFTD sizes and the NIST sizes may vary from instrument to instrument depending on the characteristics of the particle counter and original ACFTD calibration.*

Particle Size ACFTD (ISO 4402:1991) $\mu\text{m}$	Particle Size Obtained Using ISO/NIST MTD (ISO 11171) $\mu\text{m(c)}$
1	4.2
2	4.6
3	5.1
4	5.8
5	6.4
6	7.1
7	7.7
8	8.4
9	9.1
10	9.8
11	10.6
12	11.3
13	12.1
14	12.9
15	13.6
16	14.4
17	15.2
18	15.9
19	16.7
20	17.5
21	18.2
22	19.0
23	19.7
24	20.5
25	21.2
26	22.0
27	22.7
28	23.5
29	24.2
30	24.9
31	25.7
32	26.4
33	27.1
34	27.9
35	28.5
36	29.2
37	29.9
38	30.5
39	31.1
40	31.7

## Other Standards

Although the ISO 4406:1999 standard is being used extensively within the hydraulics industry other standards are occasionally required and a comparison may be requested. The following table gives a very general comparison but often no direct comparison is

## APPENDIX G

possible due to the different classes and sizes involved.

ISO 4406:1999	DEF.STD 05/42 [7] <sup>XXIX</sup>	NAS 1638[5]	SAE 749[8]	
	Table A	Table B	ISO 11218[6]	
13/11/08			2	
14/12/09			3	0
15/13/10			4	1
16/14/09		400F		
16/14/11			5	2
17/15/09	400			
17/15/10		800F		
17/15/12			6	3
18/16/10	800			
18/16/11		1,300F		
18/16/13			7	4
19/17/11	1,300	2000F		
19/17/14			8	5
20/18/12	2,000			
20/18/13		4,400F		
20/18/15			9	6
21/19/13	4,400	6,300F		
21/19/16			10	
22/20/13	6,300			
22/20/17			11	
23/12/14	15,000			
23/21/18			12	
24/22/15	21,000			
25/23/17	100,000			

**Table I**

<sup>XXIX</sup> All section headings indicated with [] are reproduced by kind permission of British Fluid Power Association from BFPA/P5 1999 issue 3 Appendix 44

## Clean working practises

The majority of hydraulic systems require cleanliness which controls below around a 40 micron threshold (beyond the limit of human eyesight). When analysing particles down to levels of 4µm, 6µm & 14µm you are talking about objects of a cellular/bacterial size. This creates various challenges, and is starting to drive better and cleaner working practices in industry. Our products are at the forefront of this challenge, and will help you to manage the quality and productivity of your systems.

### Do's

- Do use filter breathers on tank tops.
- Do use tank designs, which are self draining (sloped or conical).
- Do use tanks which can be sealed off from the surrounding environment.
- Do exercise care and use funnels when filling tanks with fluid.
- Do utilize stainless steel and methods such as electro-polishing in the design of system components upstream of your first filter set.
- Do perform off-line analysis in a controlled environment such as a laboratory which should contain fewer airborne contaminants than where the sample was taken from.
- Do use suitable, glass bottles (ideally certified clean) to take samples, along with a hand pump to reduce contamination ingress.
- Do filter your system thoroughly before using it in your production process.
- Do perform a statistically large enough sample of particle analysis results ( 25) to arrive at a base cleanliness level for your system.
- Do make sure that filters are correctly sized for your applications and cleanliness you are trying to achieve.

### Don'ts

## APPENDIX H

- Don't eat, drink or smoke around critical systems/processes.
- Don't leave tools, objects, clothing or other materials etc. on surfaces or tanks of critical systems.
- Don't use open tanks on critical systems.
- Don't take samples or perform on-line analysis from the top of a reservoir/tank.
- Don't design/use tanks which contain crevices (internal corners etc).
- Don't assume that if a sample looks clean, that it is. You won't be able to see the contaminants.
- Don't perform off-line analysis in an "un-controlled" environment. E.g. workshop.
- Don't rely on a single test for a capable representation of your system.
- Don't start using your system/process until it has gone through a commissioning period whereby contamination levels are relatively stable.
- Don't mix fluids into the same system. They can emulsify and eliminate any chance of a reliable particle count.
- Don't use unsuitable containers to take a fluid sample.



***Produced by MP Filtri UK***

**Revision 0.31**

As a policy of continual improvement, MP Filtri UK reserve the right to alter specifications without prior notice.

Except as permitted by such licence, no part of this publication may be reproduced, stored in retrieval system or transmitted, in any form or any means, electronic, mechanical, recording, or otherwise, without prior written permission of MP Filtri UK.

